

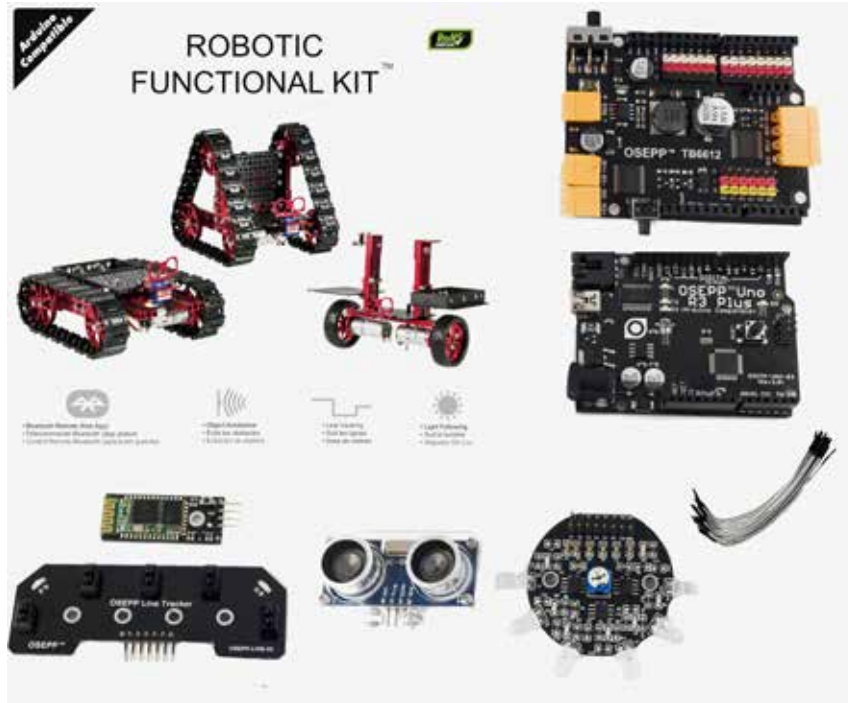

# ROBOTIC FUNCTIONAL KIT™

## Wiring Instructions



# Table of Contents

## 2 WHEELER MECHANICAL KIT

Balancing Function	1
Bluetooth Control Wiring	6

## TANK

Bluetooth Control	13
Light Following with Object Avoidance	23
Line Following with Obstacle Detection	35
Line Maze Discovery	49
Object Avoidance	60

## TRIANGULAR TANK

Bluetooth Control	68
Light Following with Object Avoidance	79
Line Following with Obstacle Detection	97
Line Maze Discovery	113
Object Avoidance	125

# 1 2 WHEELER MECHANICAL KIT

Balancing Function



# 2

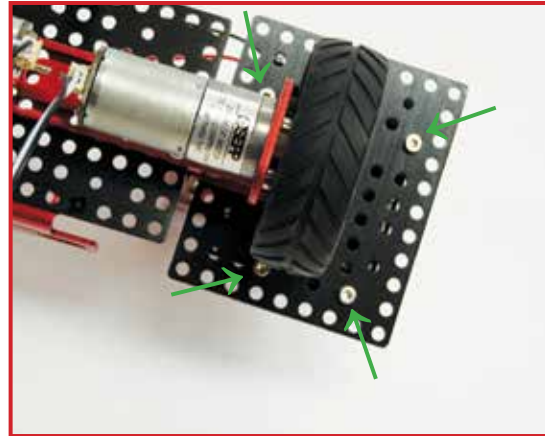
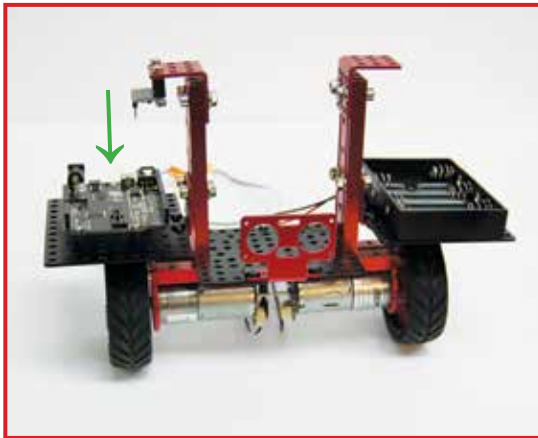

# 3

---

TBSHD-01



1x

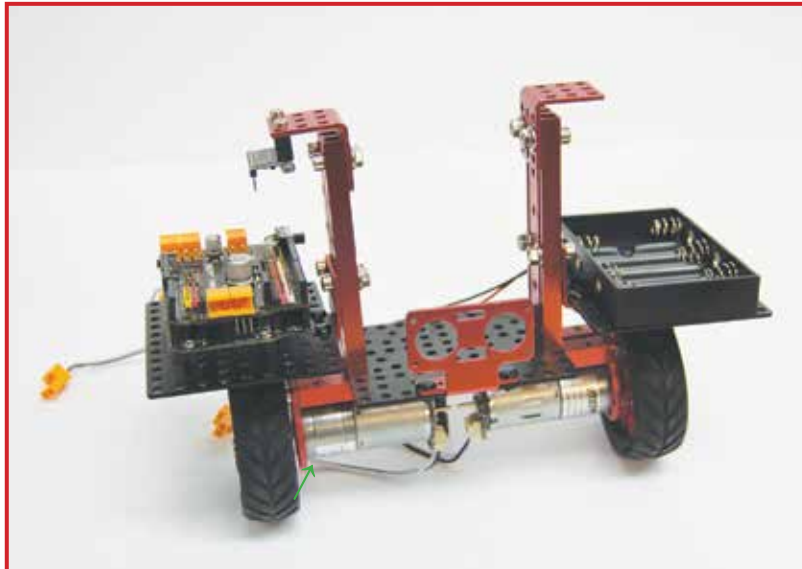

# 4

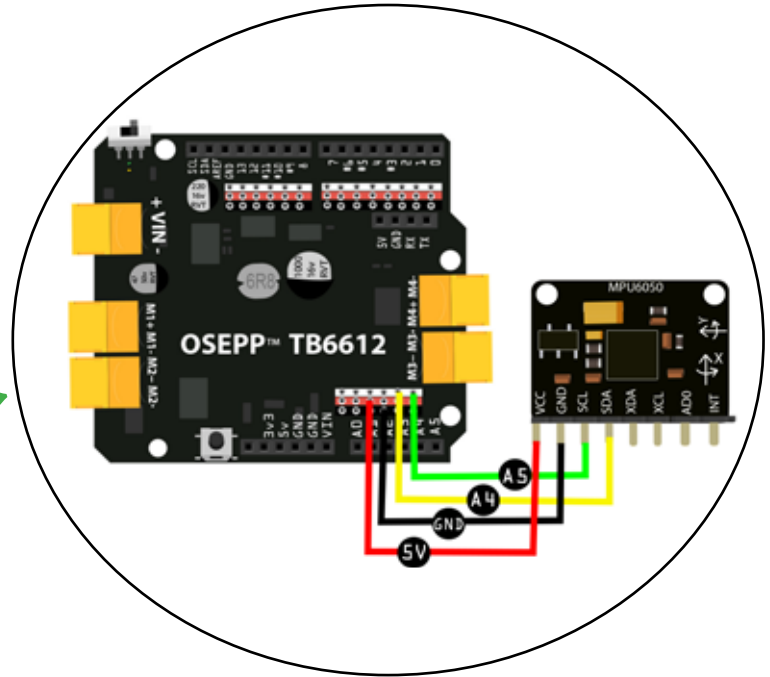
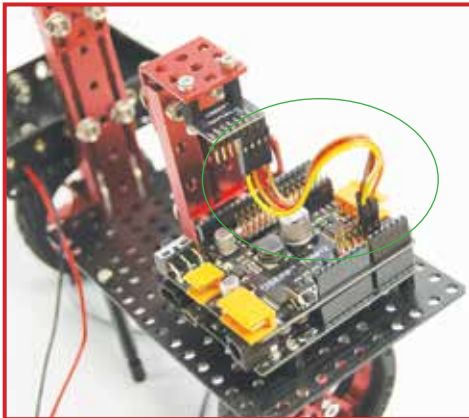

# 5

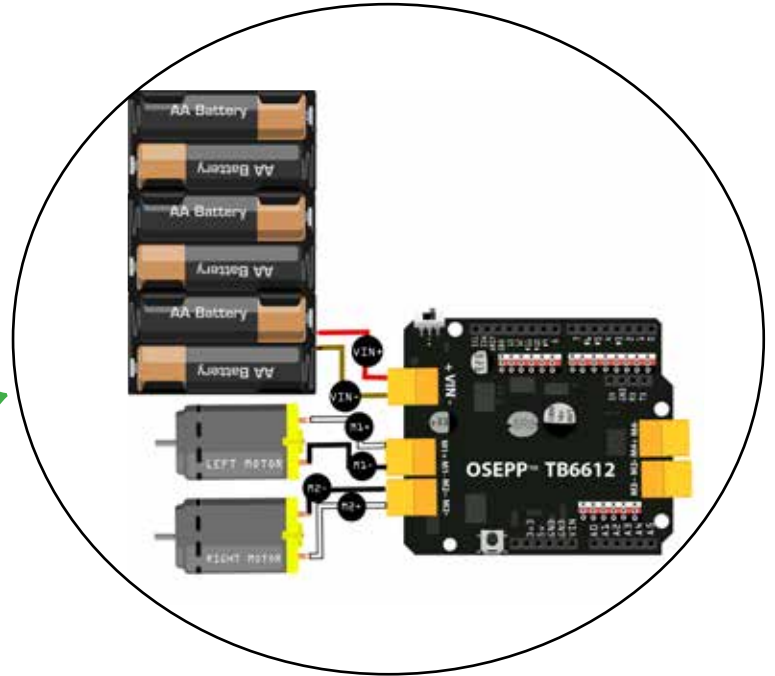
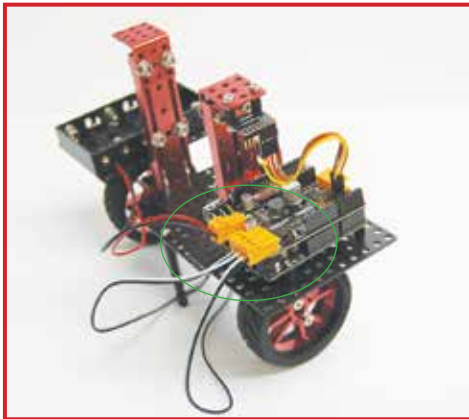

# 1 2 WHEELER WITH WHEEL ENCODER

## Bluetooth Control Wiring

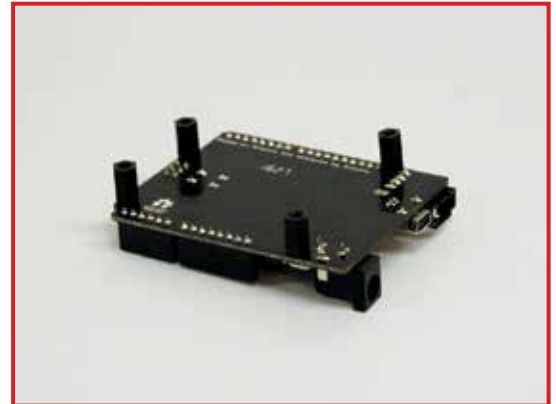



# 2

---

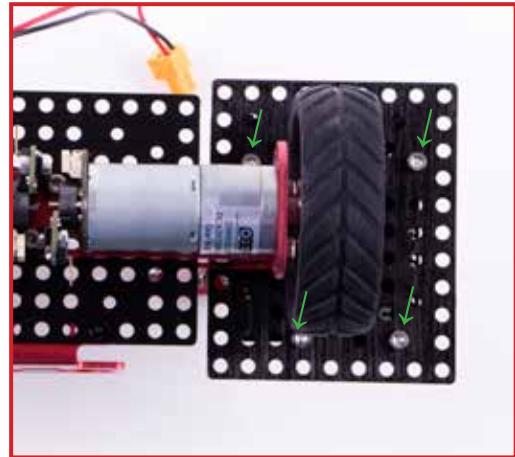
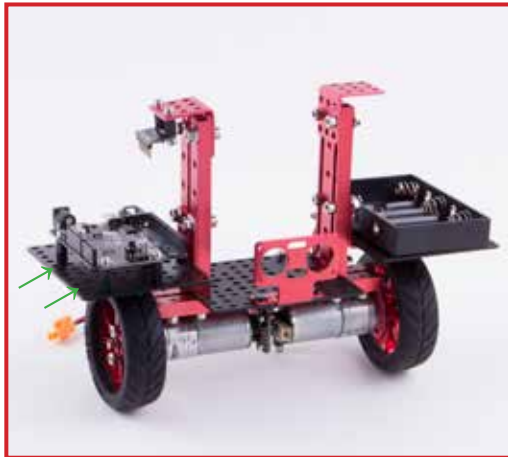

# 3

---

TBSHD-01



x 1



# 4

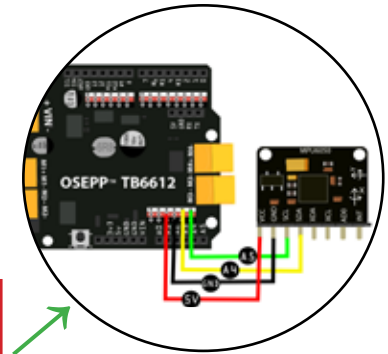
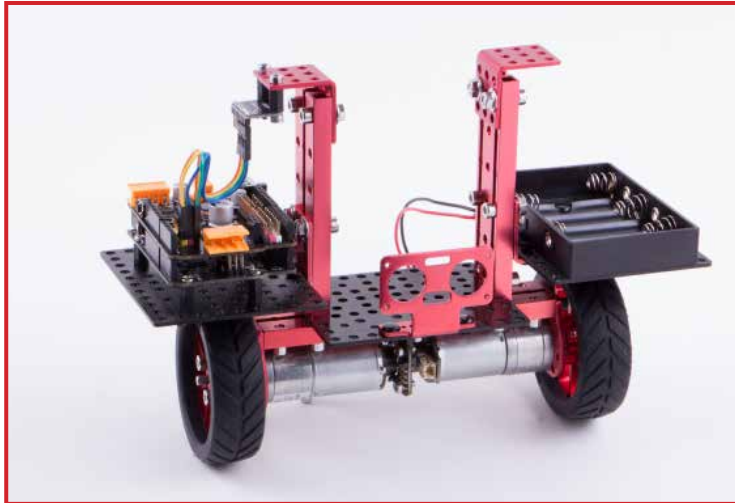

# 5

BTM-01



x 1

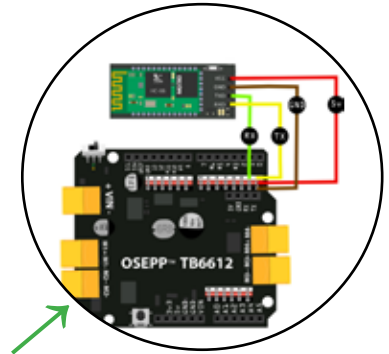

# 6

RIBBON  
JUMPERS  
20CM



x 4

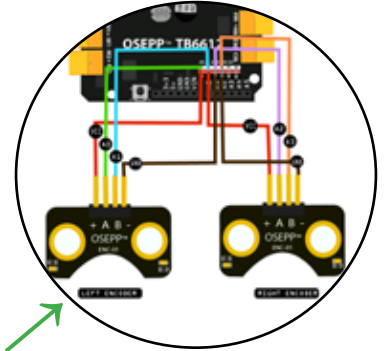

# 7

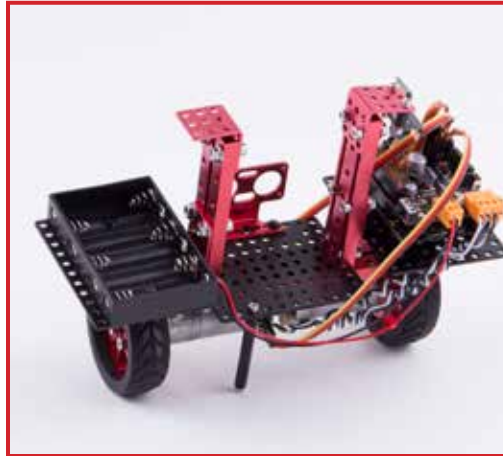
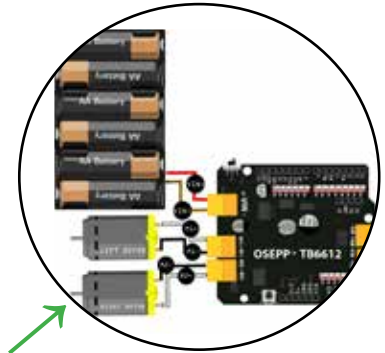

# 1 **TANK** Bluetooth Control

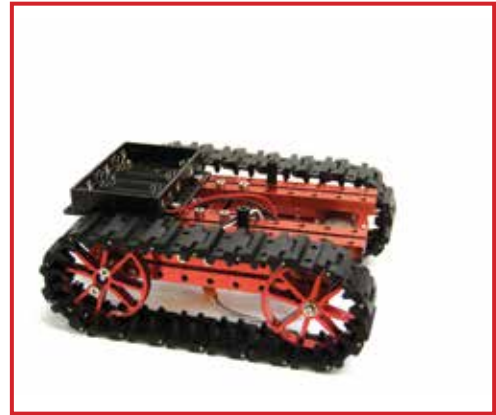
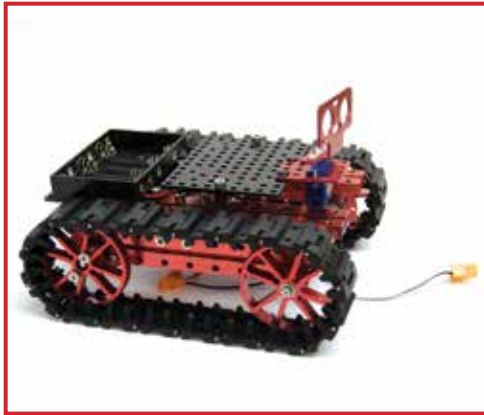

# 2

---

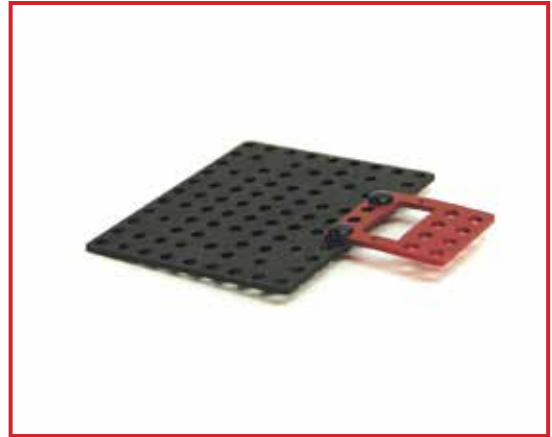
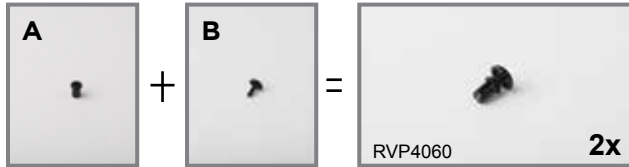



# 3

---

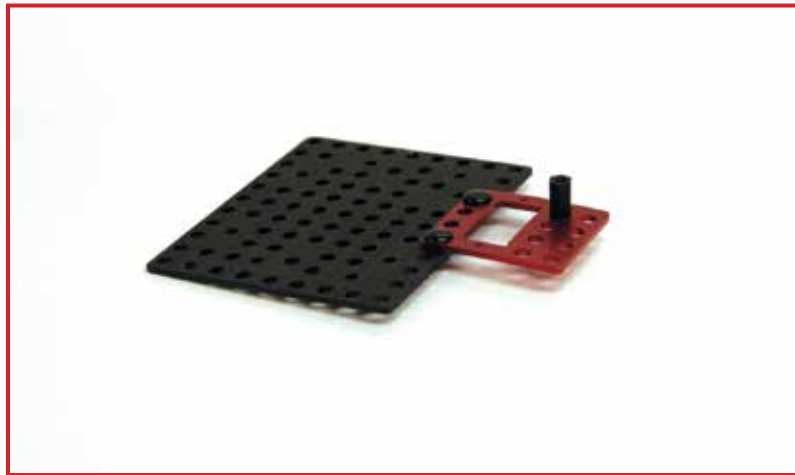
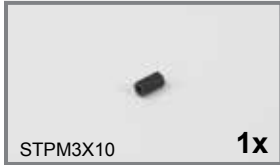

# 4

---

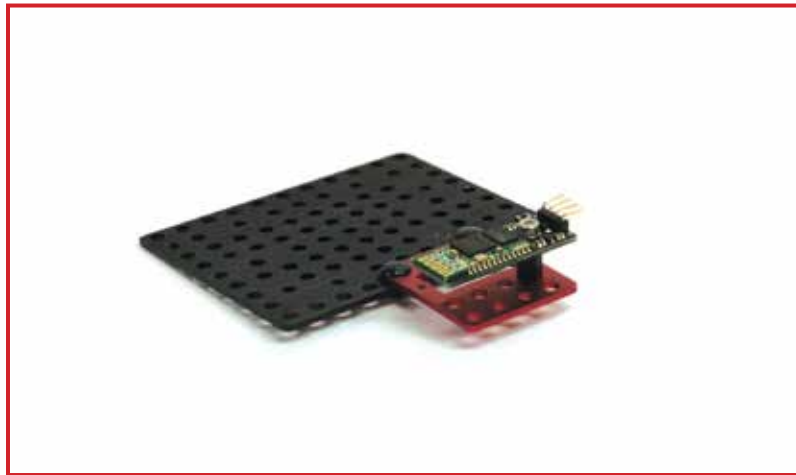
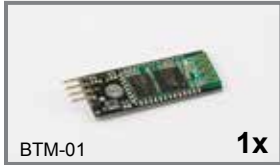

# 5

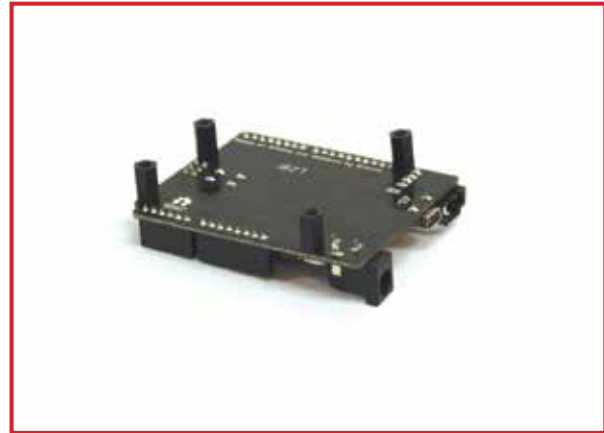

# 6

---

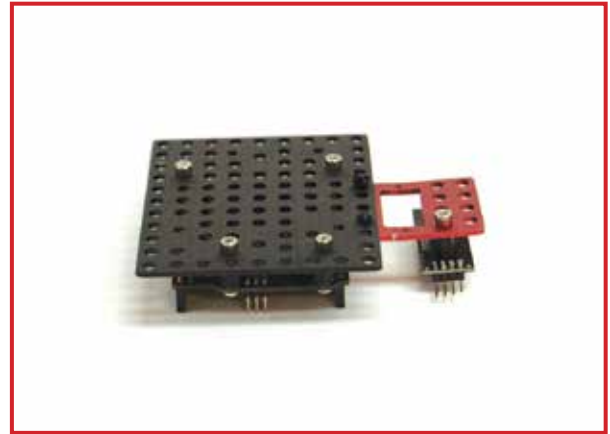
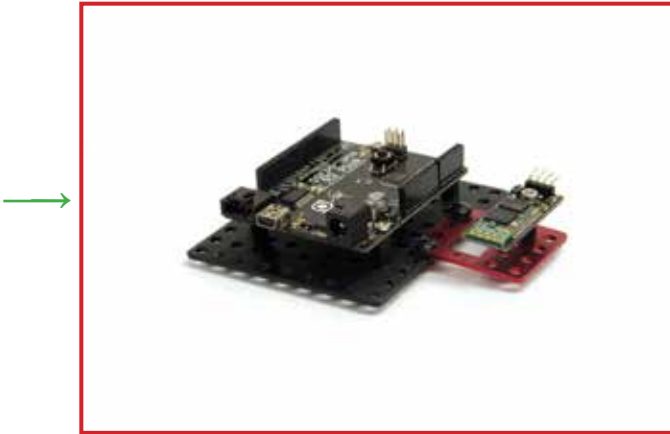

# 7

---

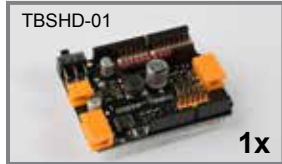

# 8

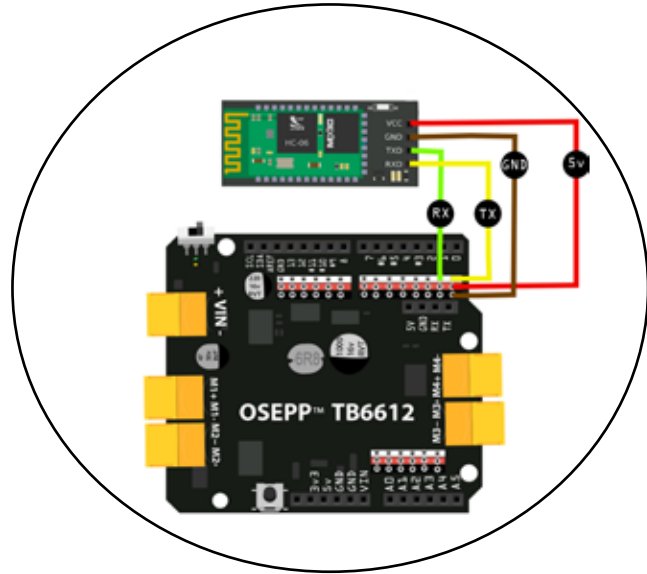
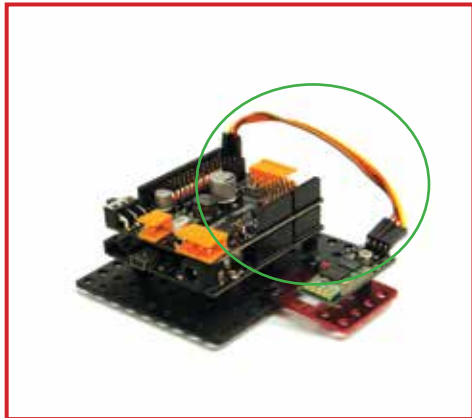

# 9

---



# 10

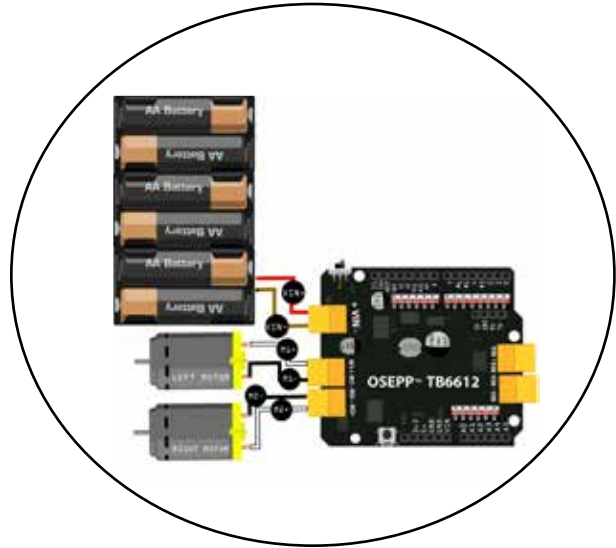
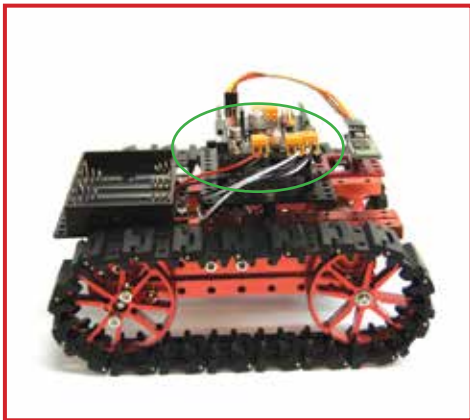



# 1

# TANK Light Following with object avoidance

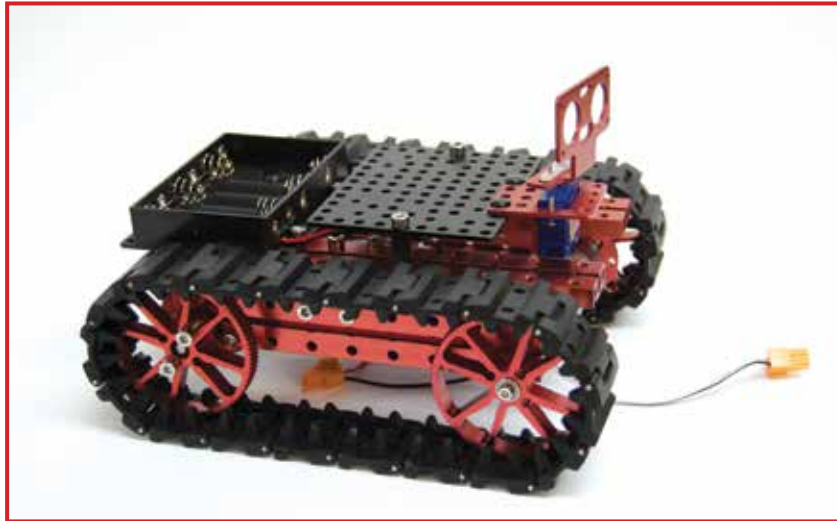

# 2

---

TANK-01



Ⓐ

ALKEY30

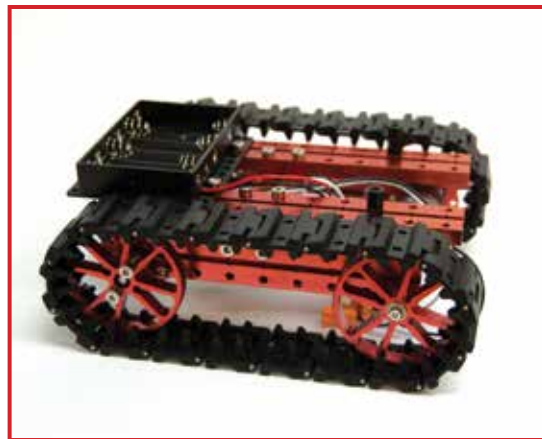

# 3

---



# 4

---

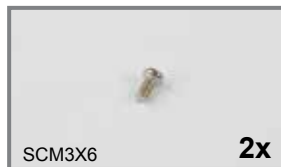

# 5

---

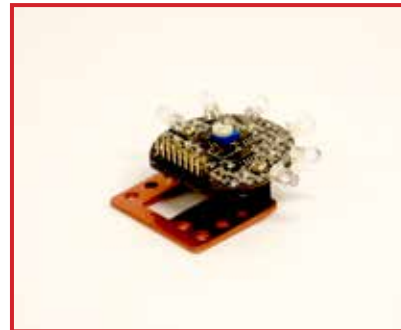
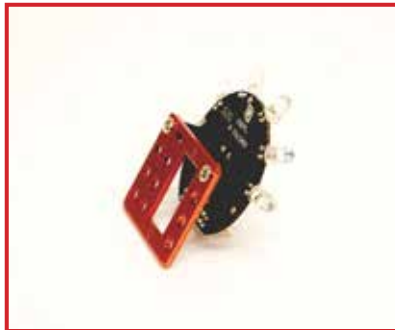

# 6

---

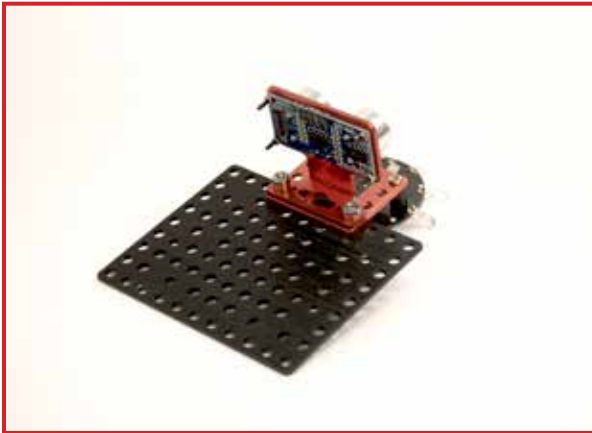

# 7

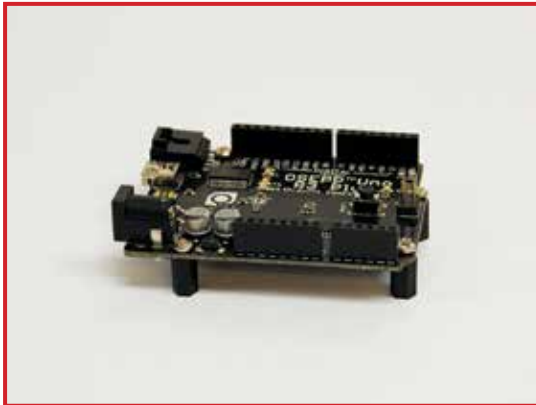
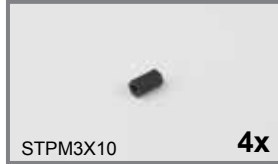

# 8

---

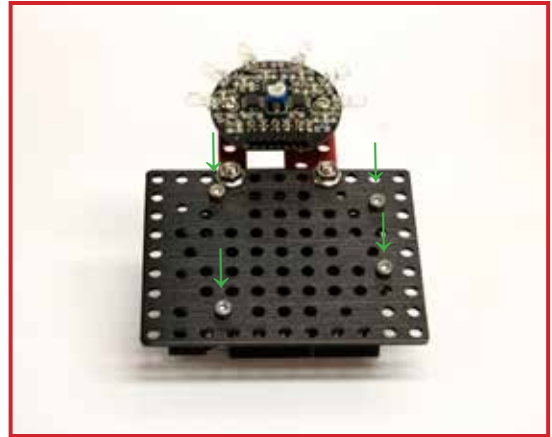
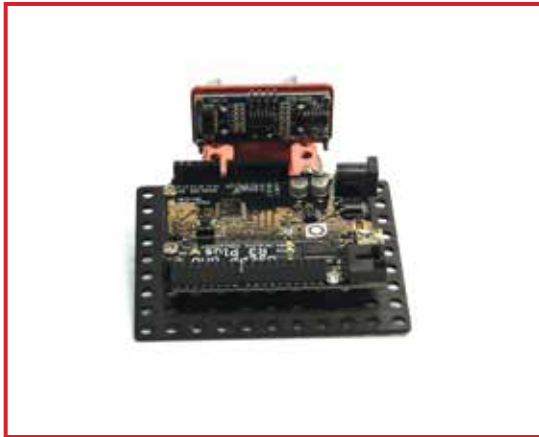



# 9

---

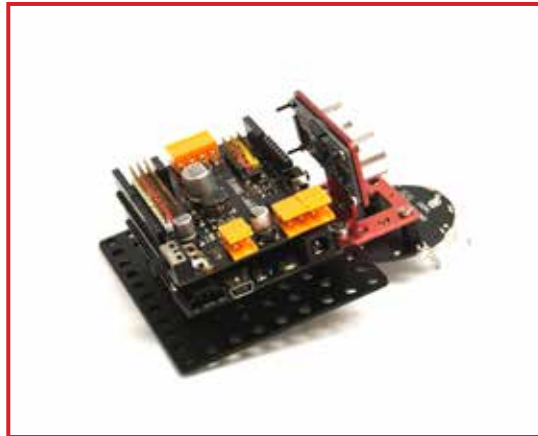
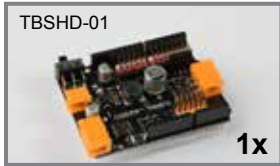

# 10

RIB15CM



8x

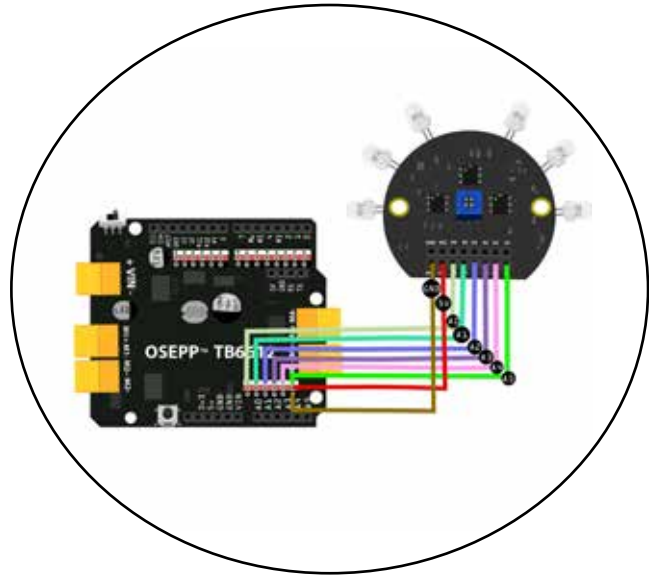
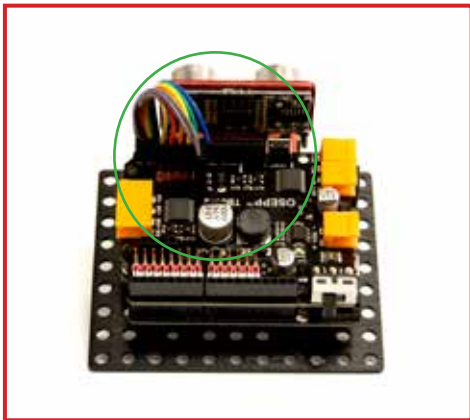

# 11

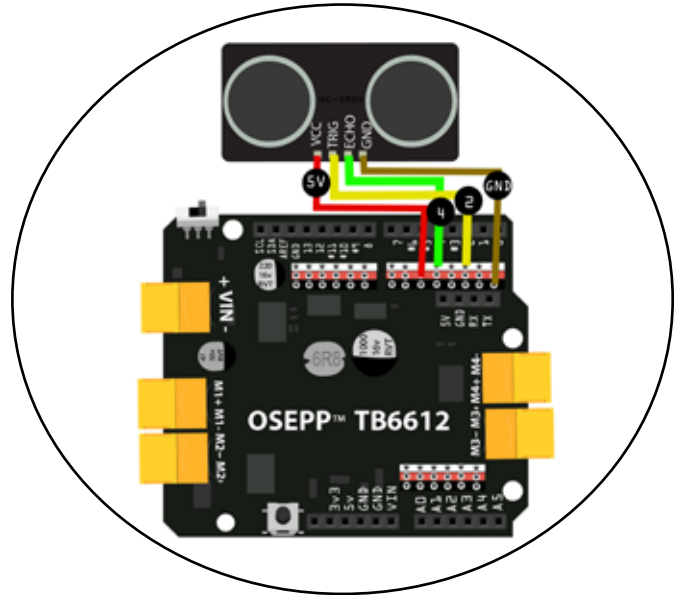
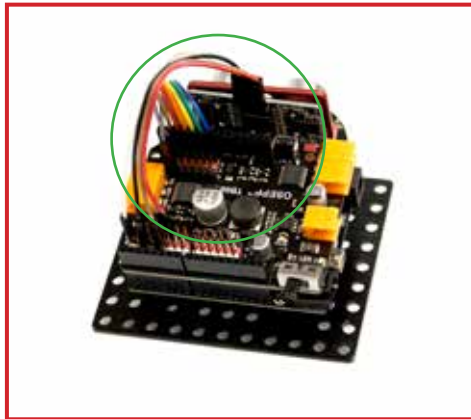

# 12

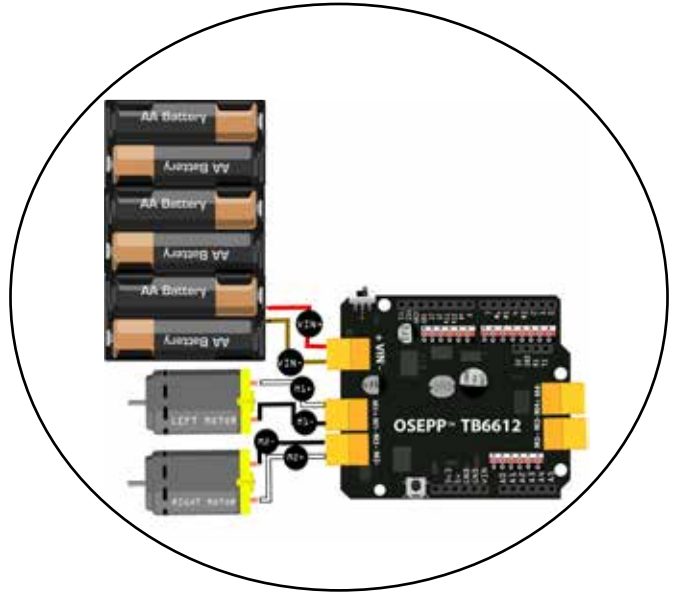
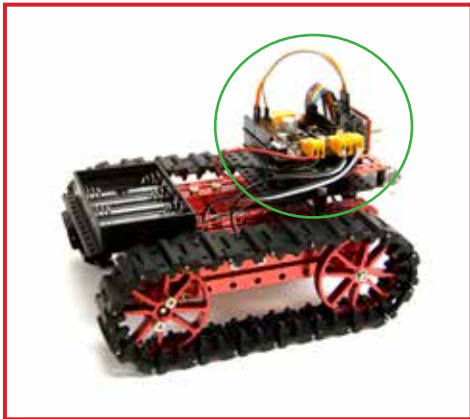

# 1 **TANK** Line Following with Obstacle Detection

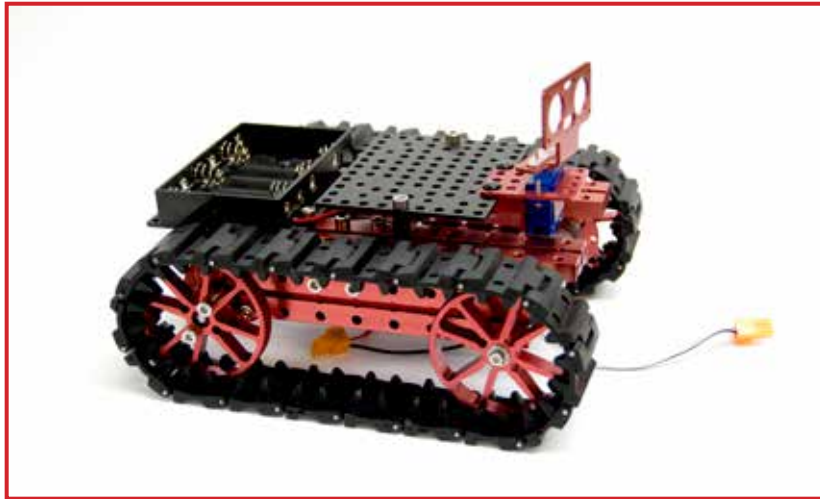

# 2

---

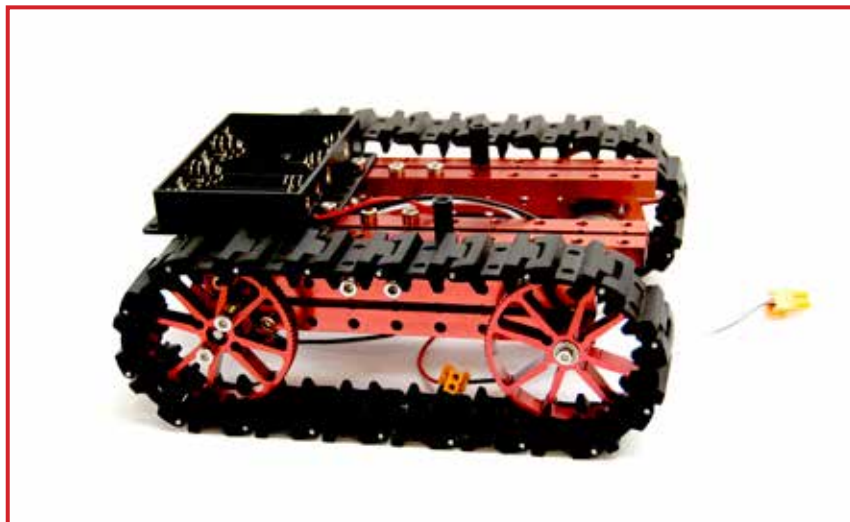

# 3

---

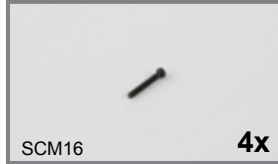

# 4

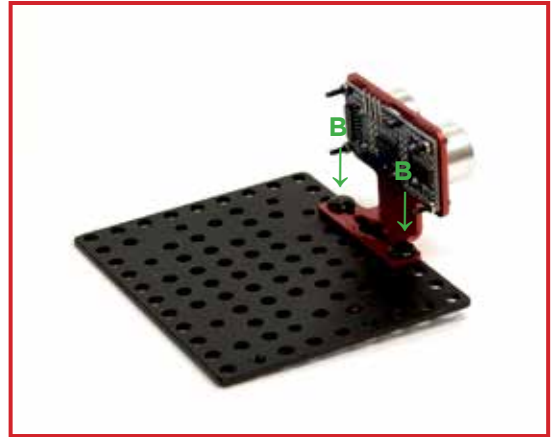
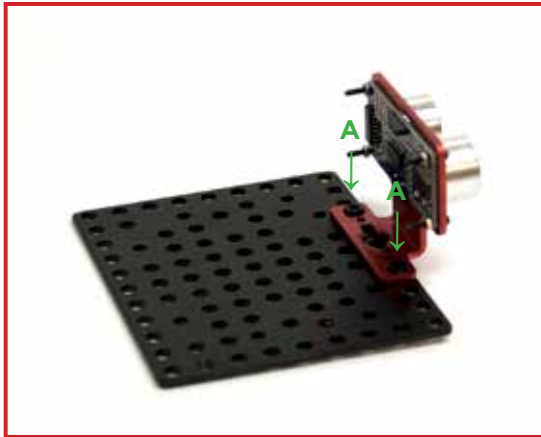



# 5

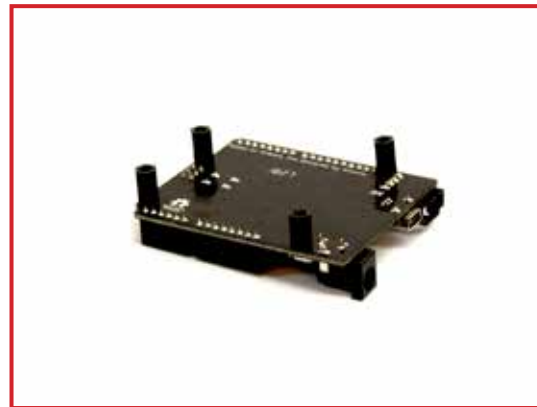
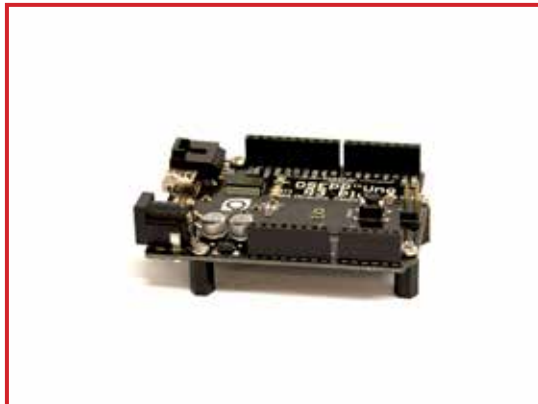

# 6

---

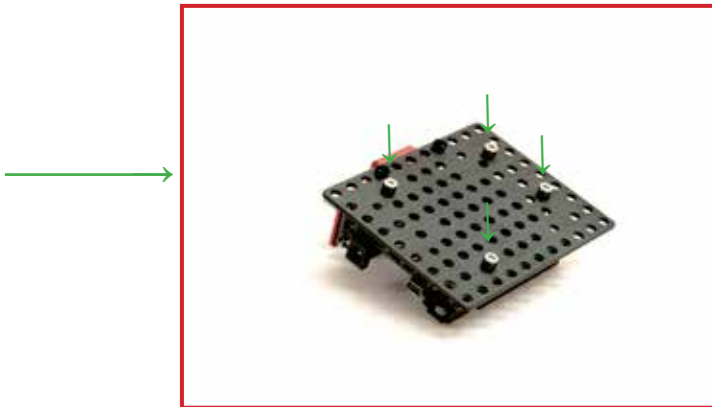

# 7

---

TBSHD-01



1x



# 8



# 9

---

TANK-01



HEXM3X6

**2x**

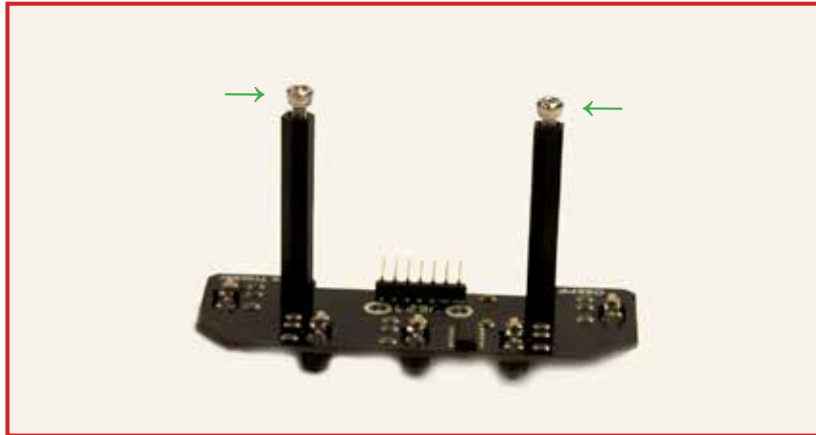

# 10

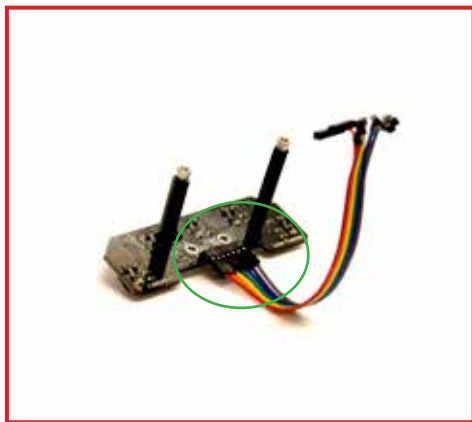
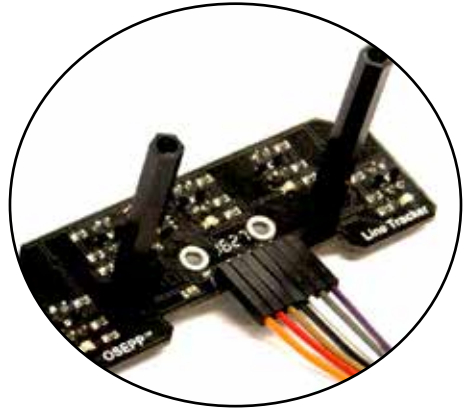

# 11

TANK-01



Ⓑ

ALKEY25

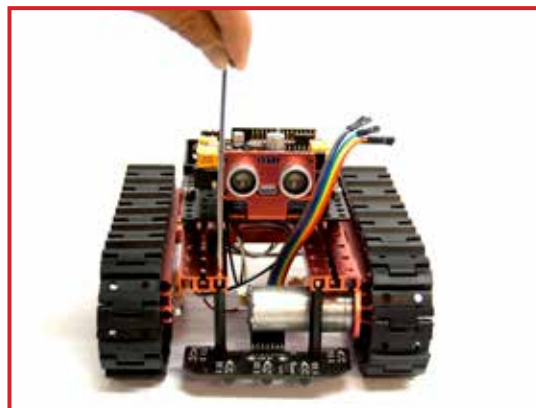
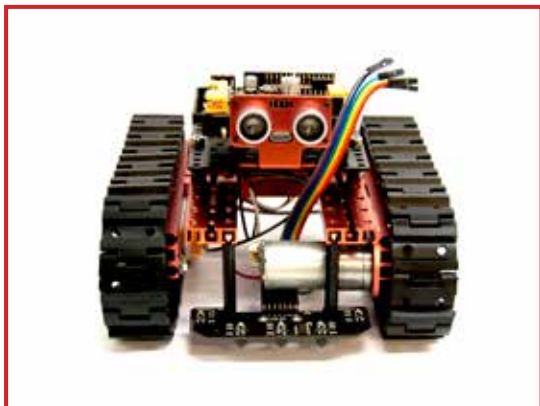

# 12

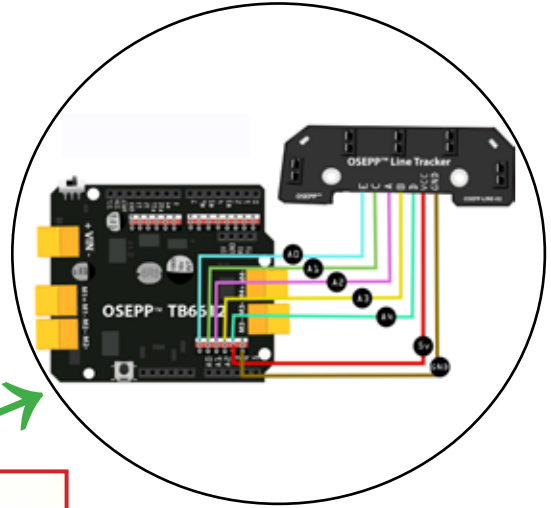
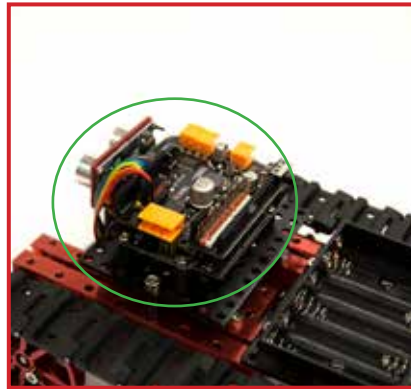
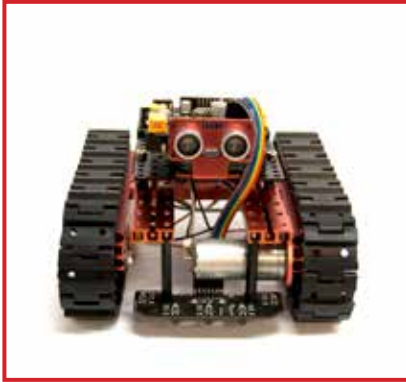



# 13

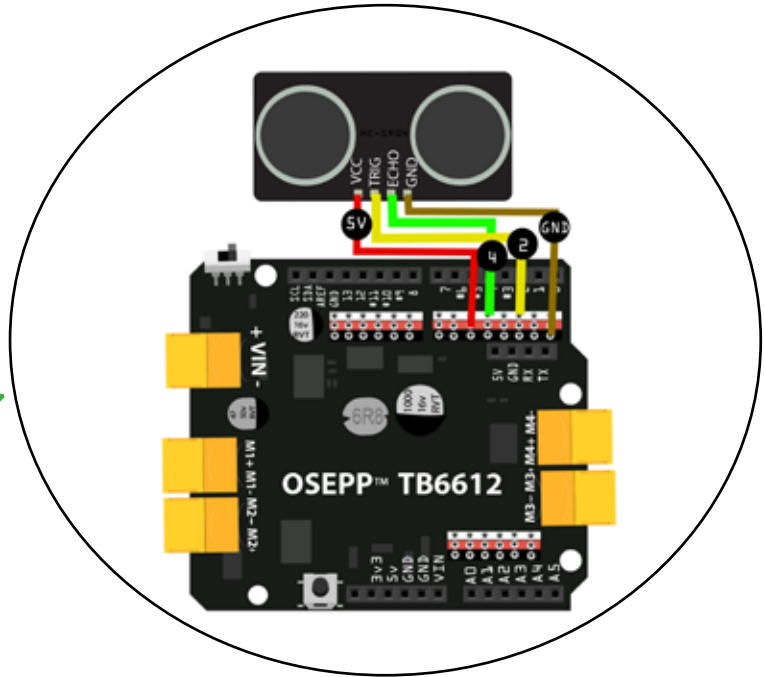
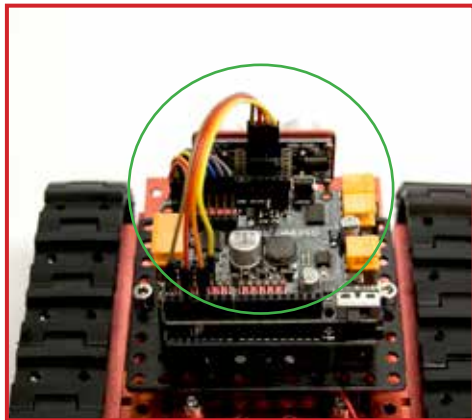

# 14

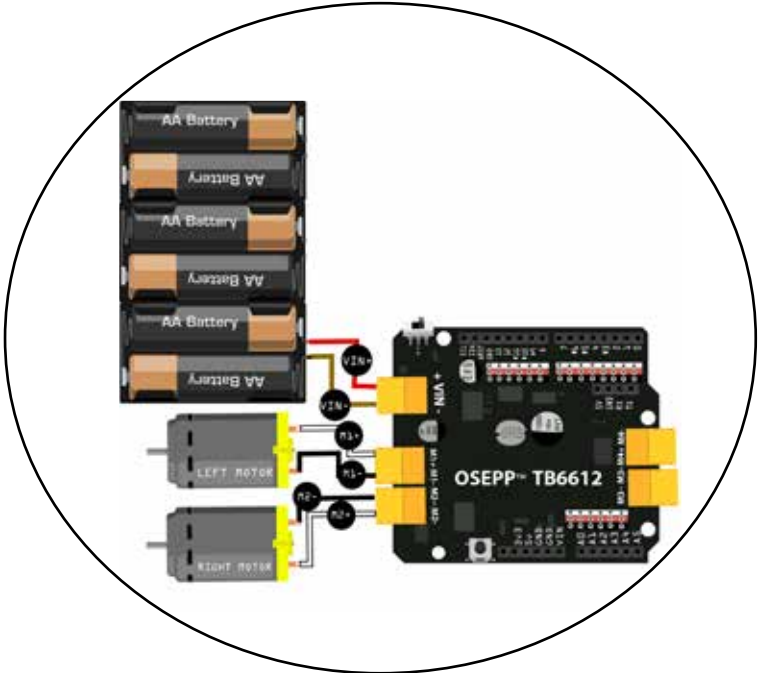
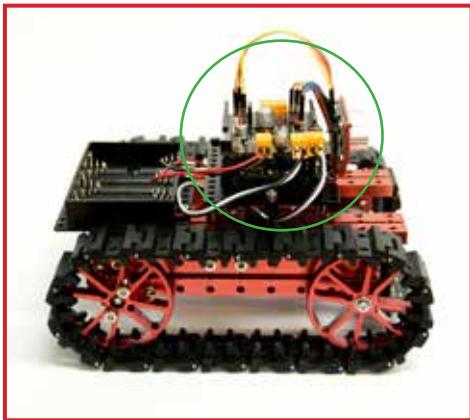

1

# TANK Line Maze Discovery



TANK-01

1x

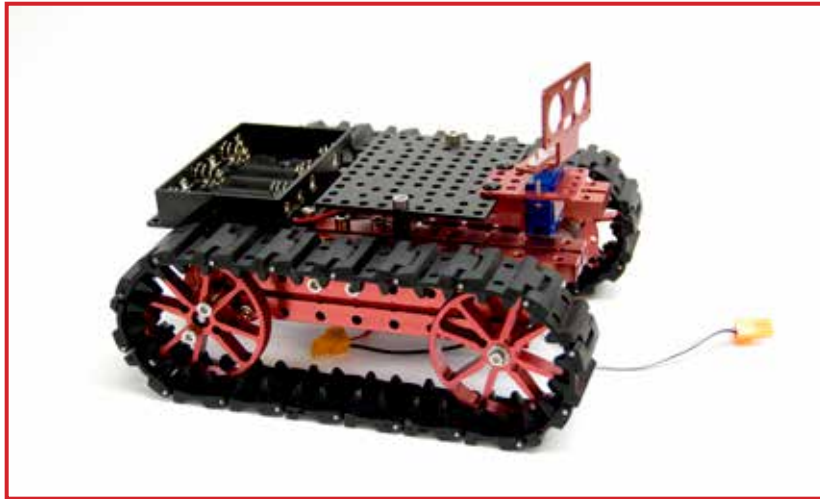

# 2

---

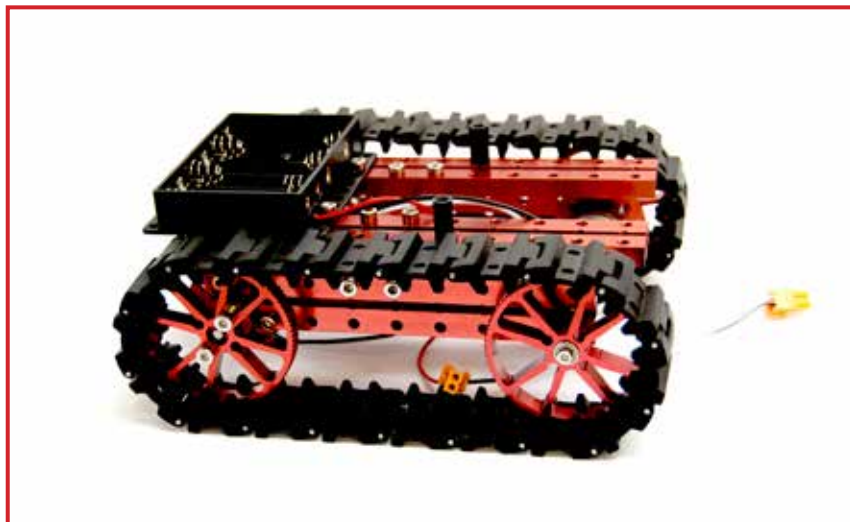

# 3

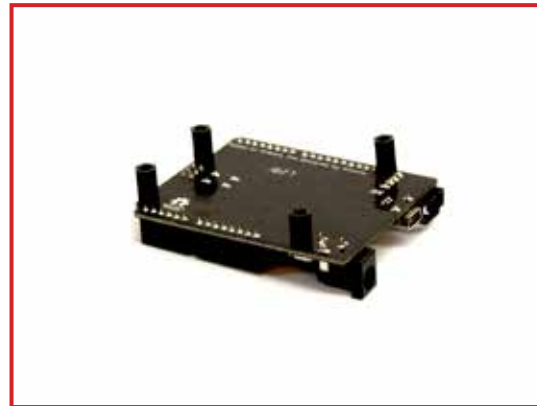
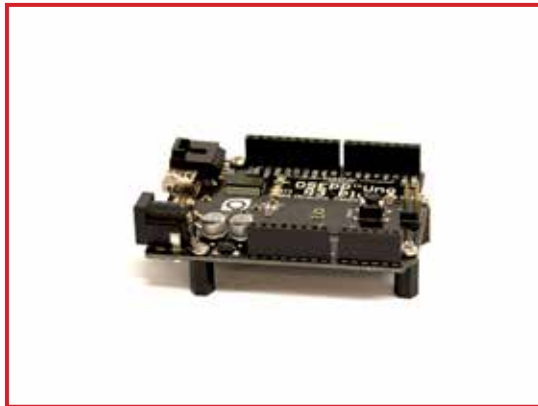

# 4

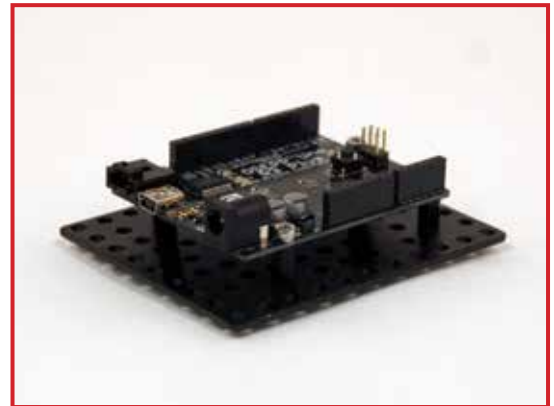
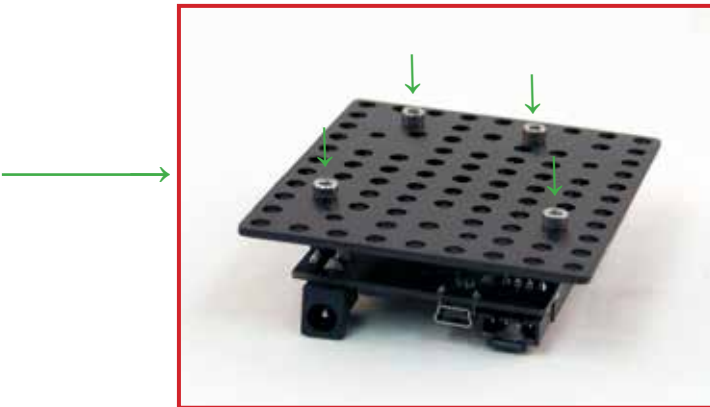

# 5

---

TBSHD-01

1x



# 6





# 7

---

TANK-01



HEXM3X6

**2x**

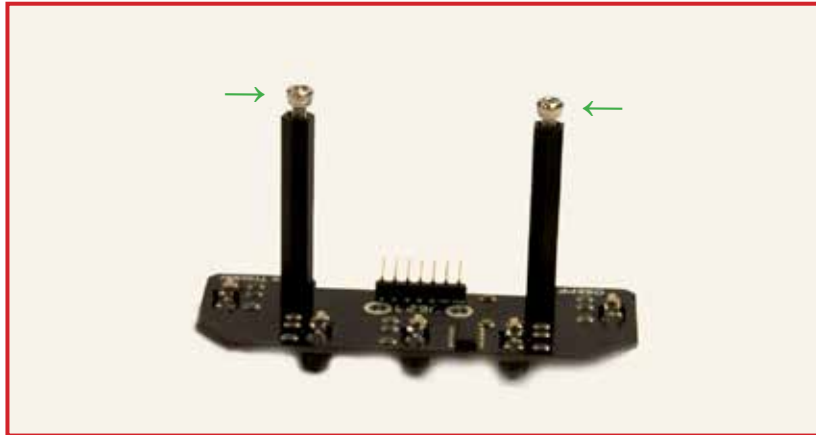

# 8

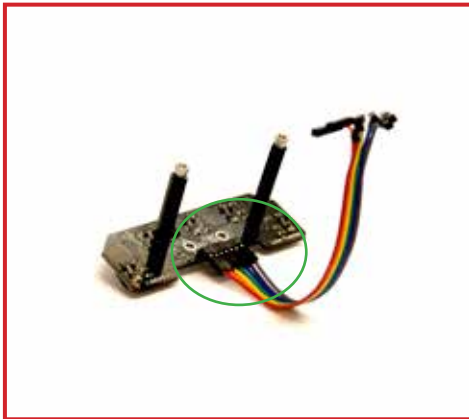
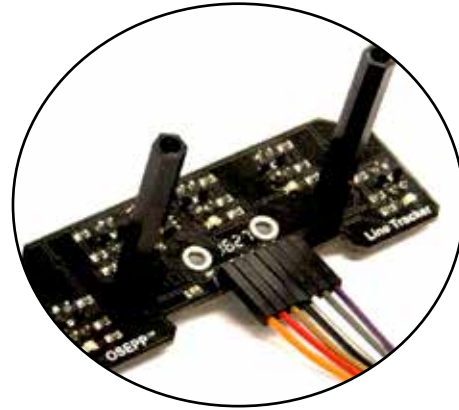

# 9

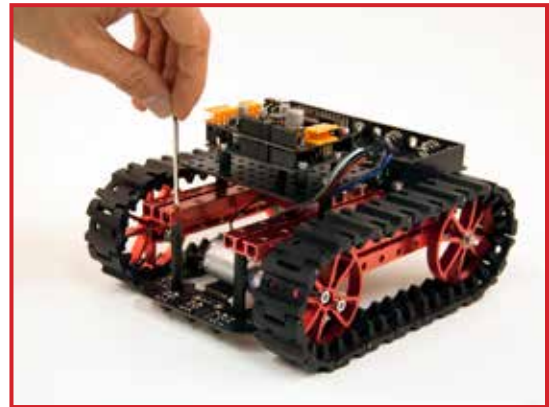
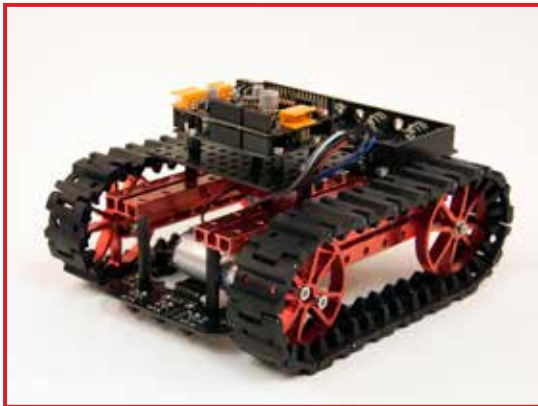

# 10

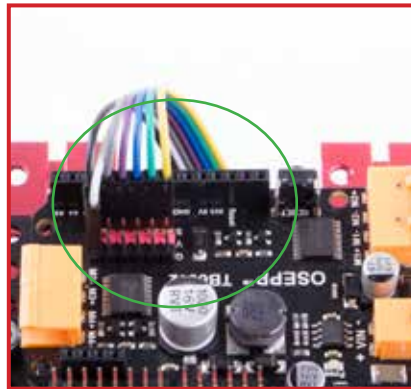
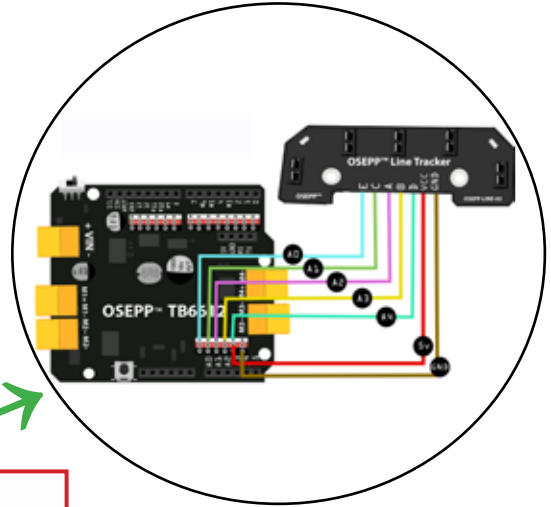
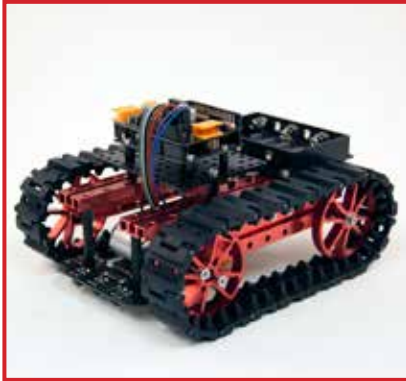

# 14

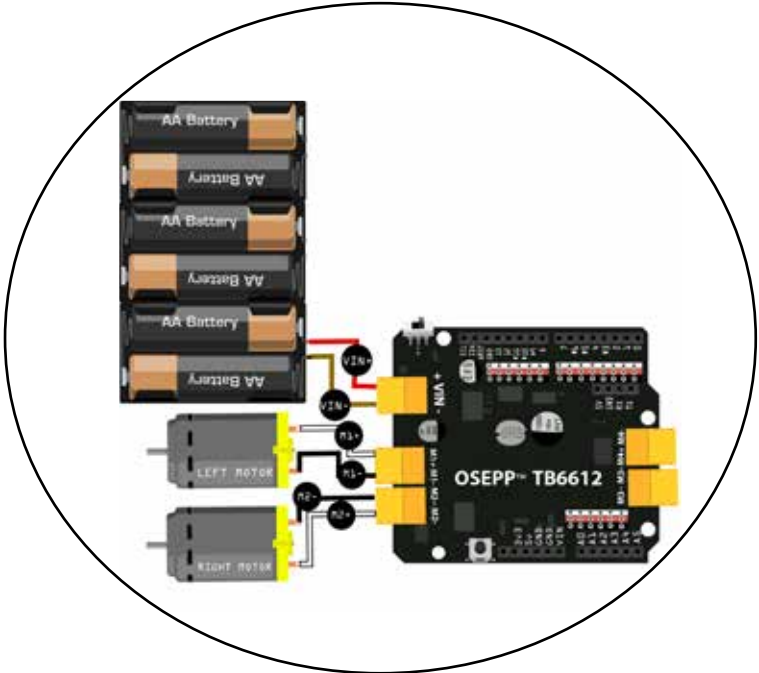
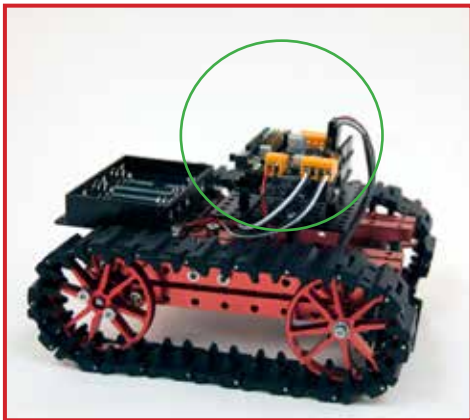

# 1 **TANK** Object Avoidance

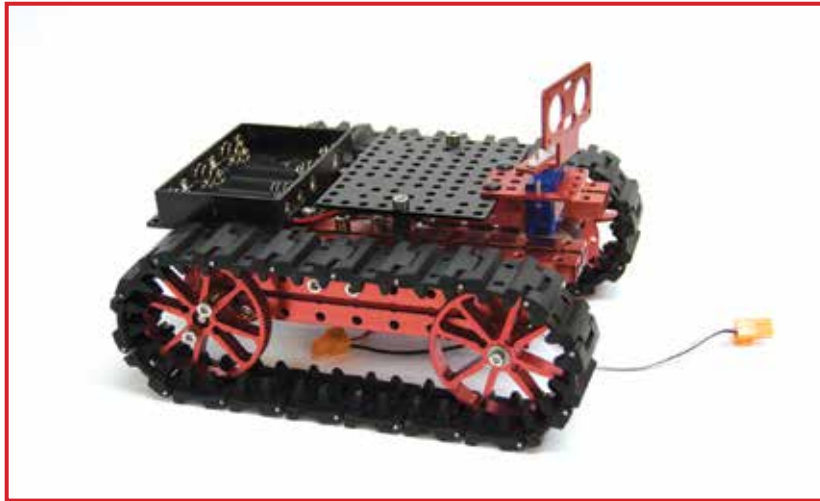

# 2

---



# 3

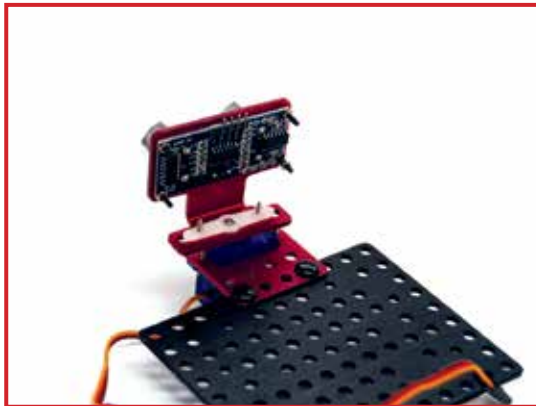
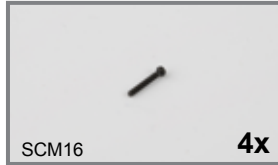



# 4

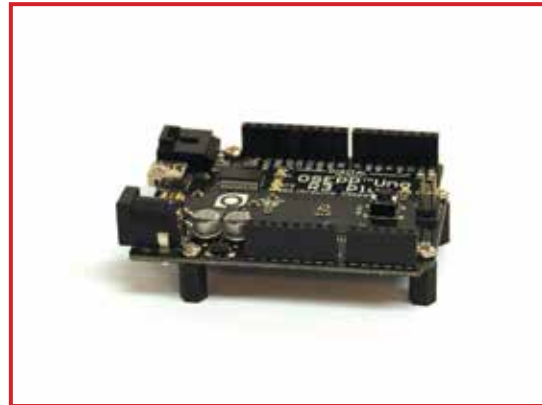
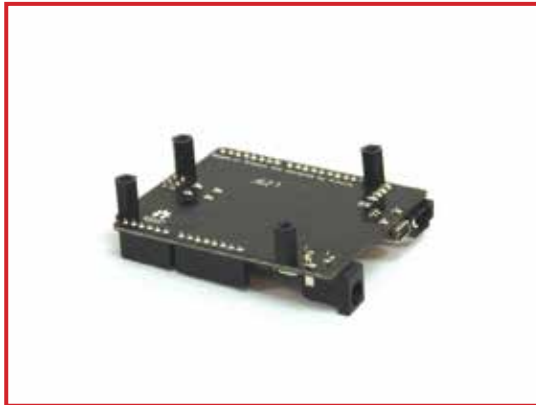
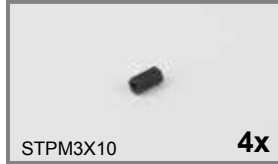

# 5

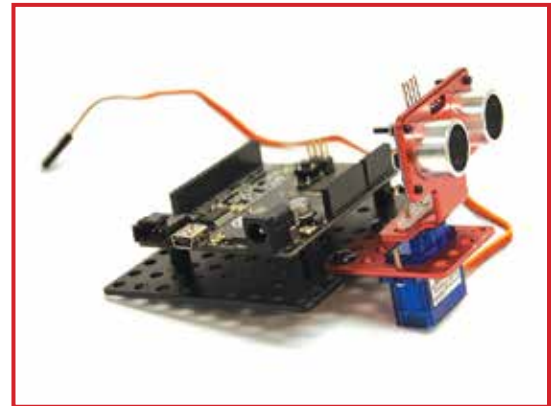
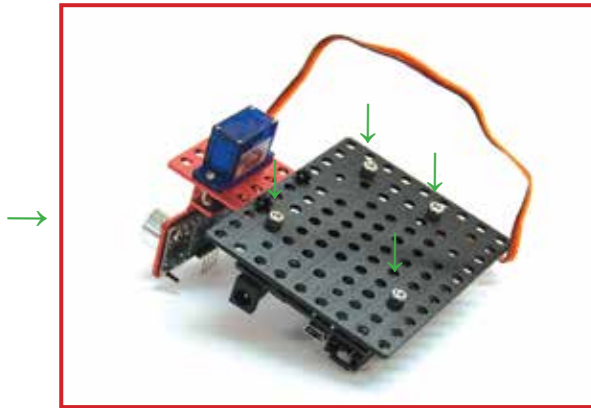

# 6

---

TBSHD-01

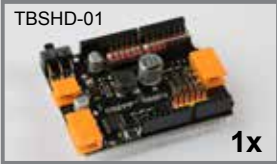

1x



# 7

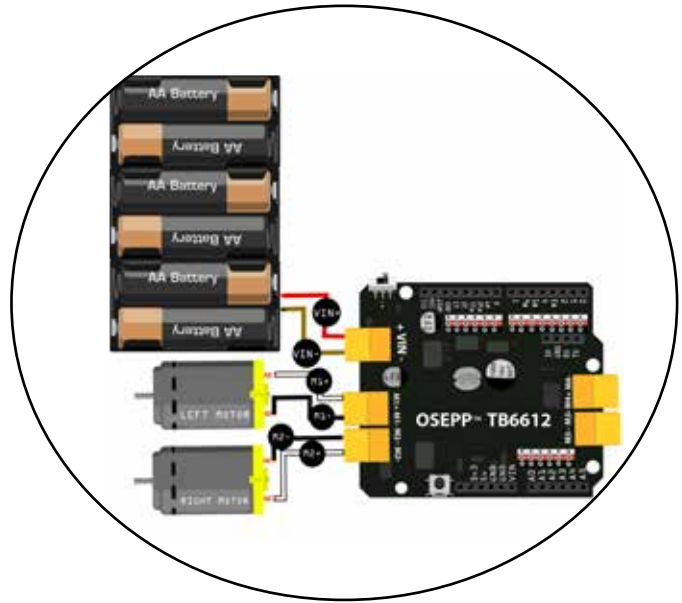
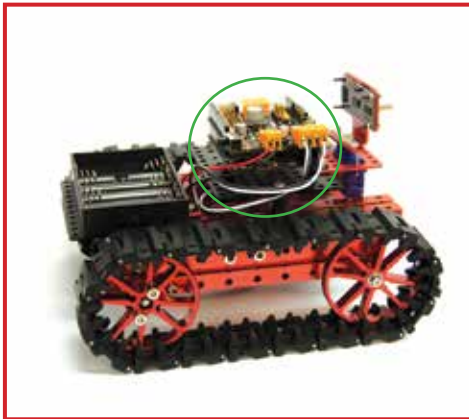

# 8

RIB10CM



4x

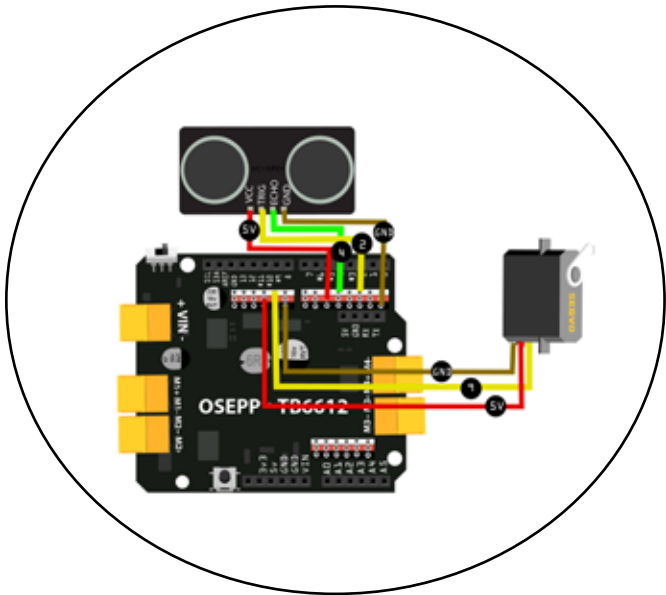
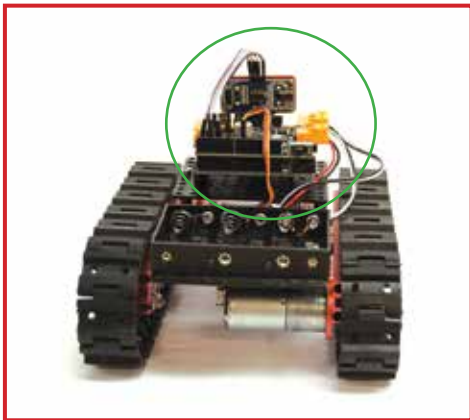

# 1

# TRIANGULAR TANK

Bluetooth Control



# 2

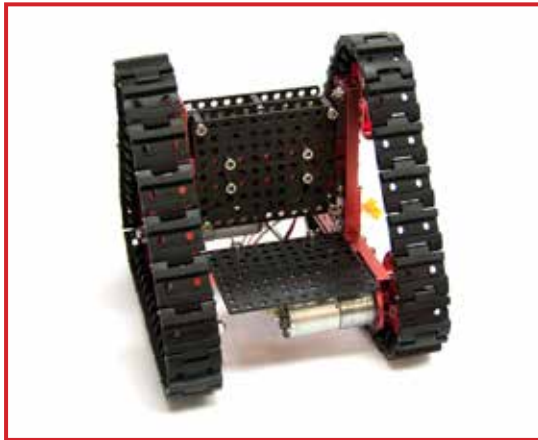

# 3

---

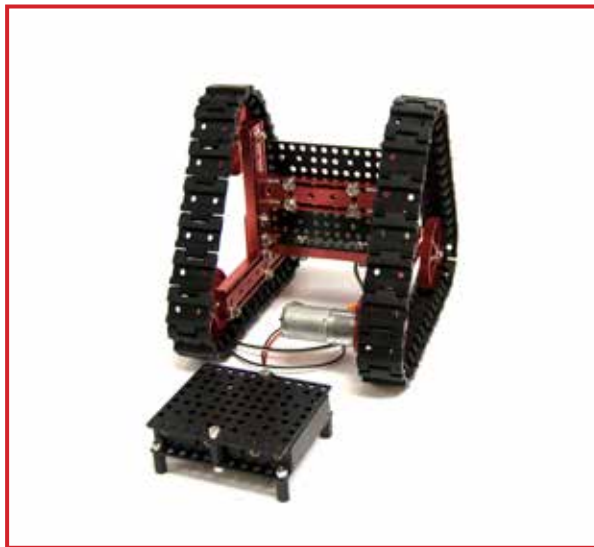



# 4

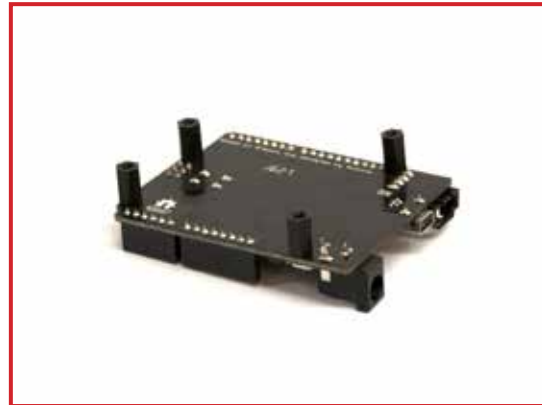
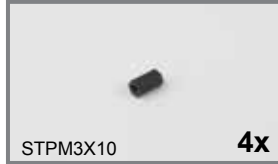

# 5

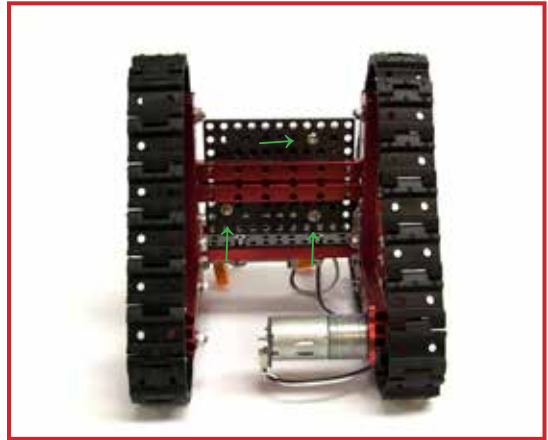
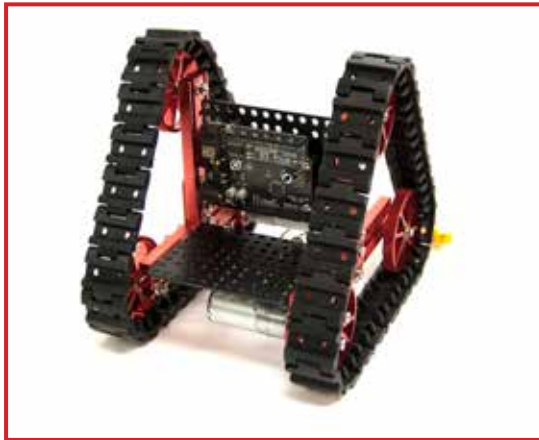

# 6

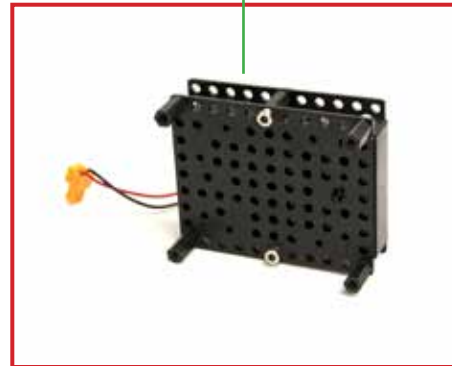
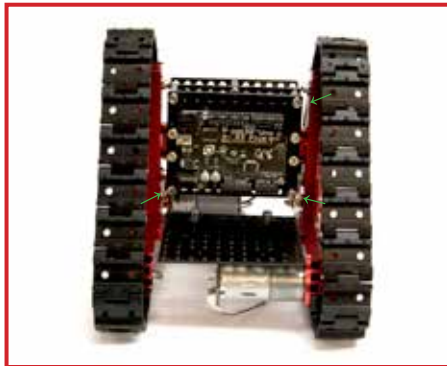
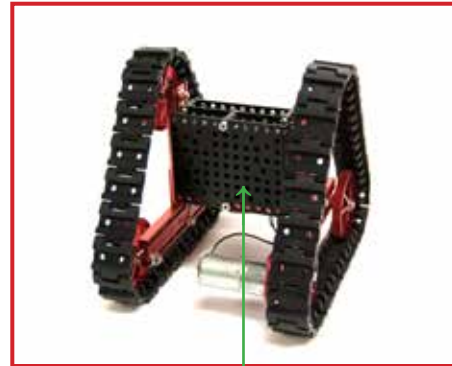

# 7

---

TBSHD-01



1x



# 8

---

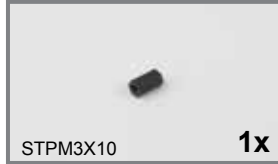
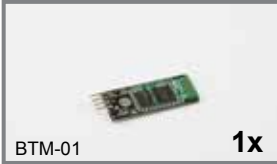

# 9

---

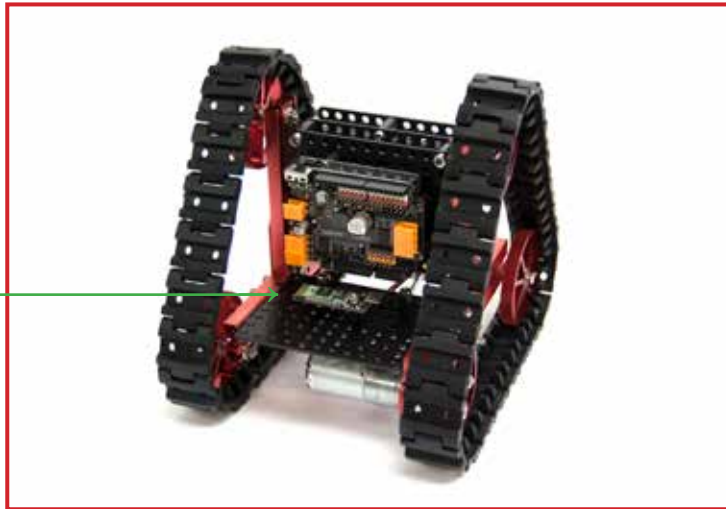

# 10

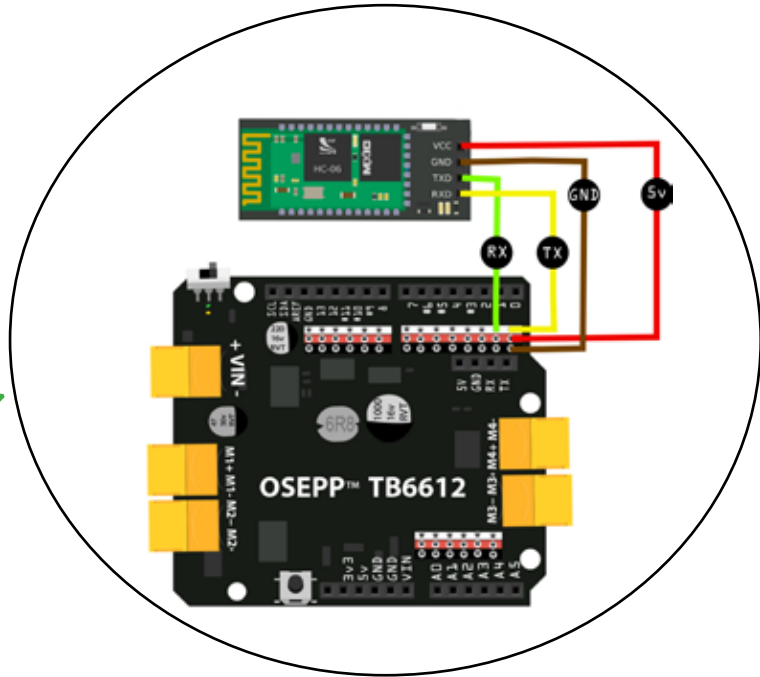

# 11

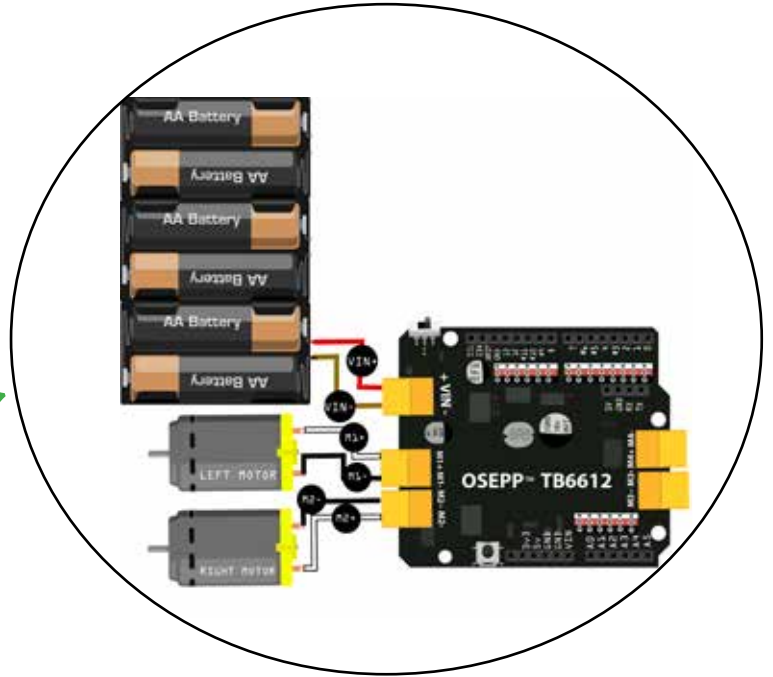
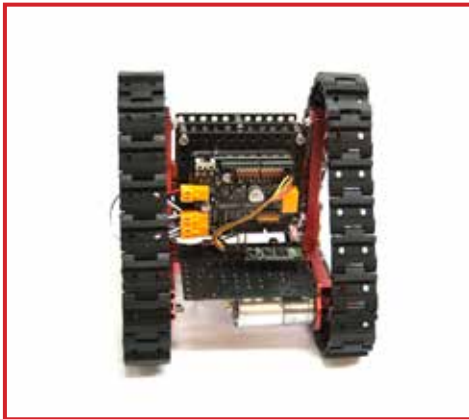



1

# TRIANGULAR TANK

Light following with object avoidance



# 2

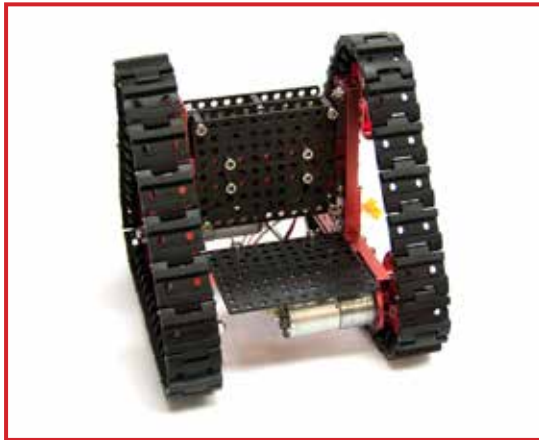

# 3

---

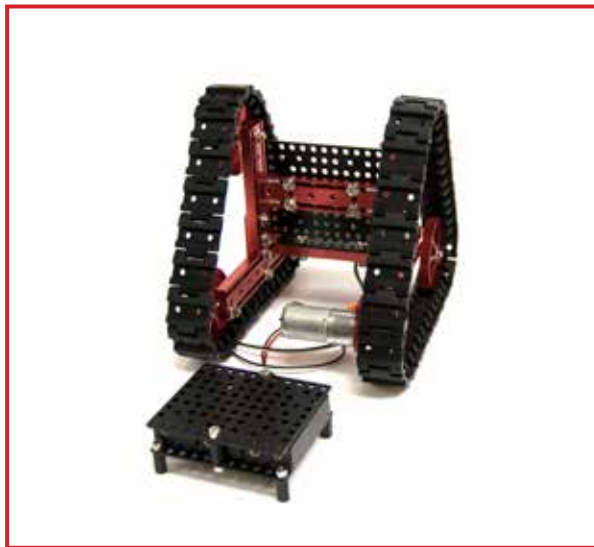

# 4

---

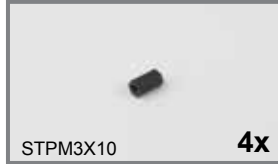

# 5

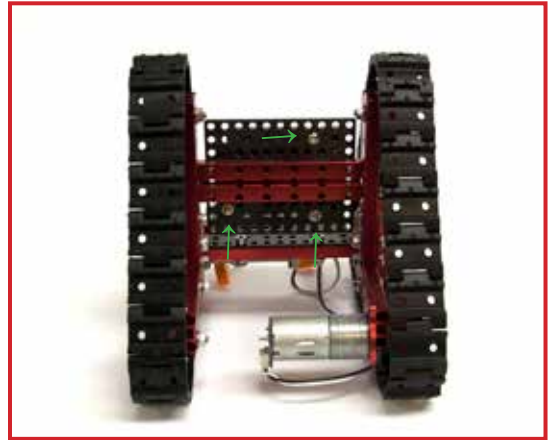

# 6

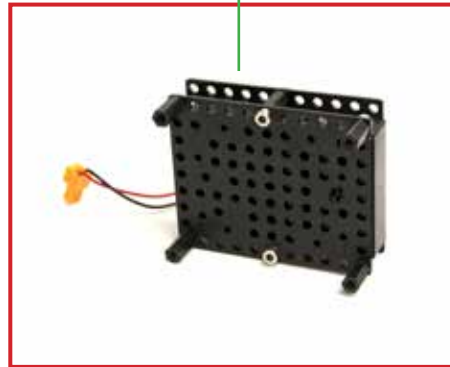
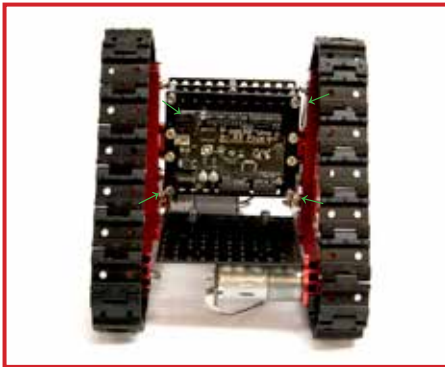
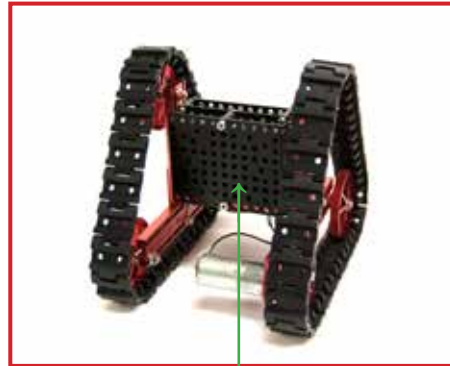

# 7

---

TBSHD-01



1x



# 8

---

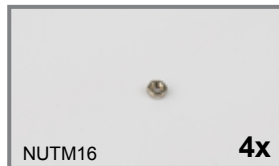



# 9

---



# 10

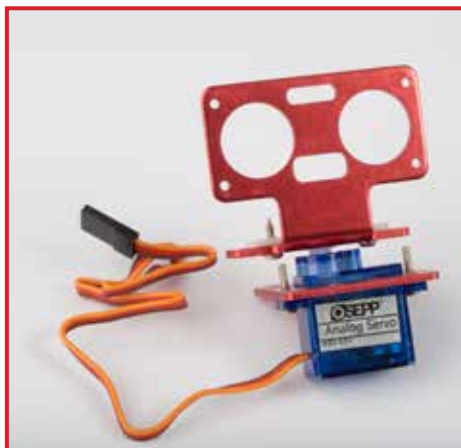
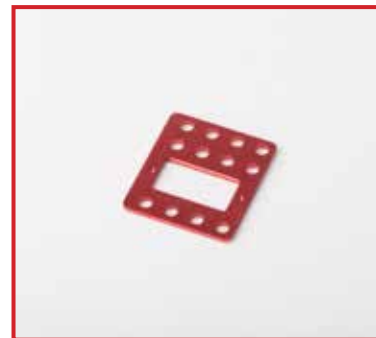

# 11

---

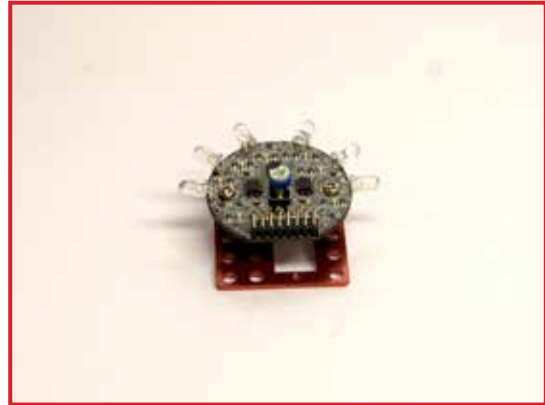

# 12

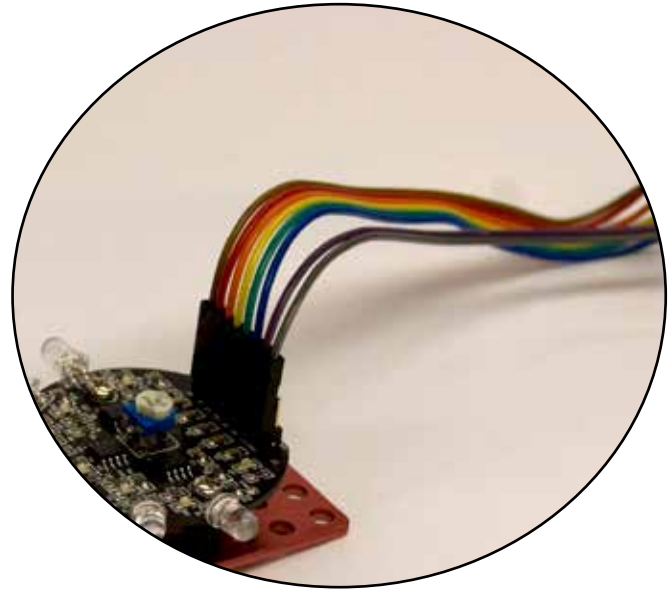
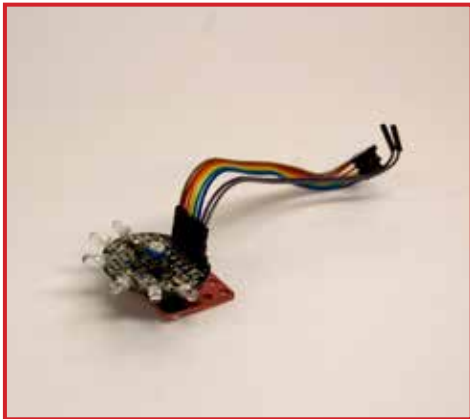

# 13

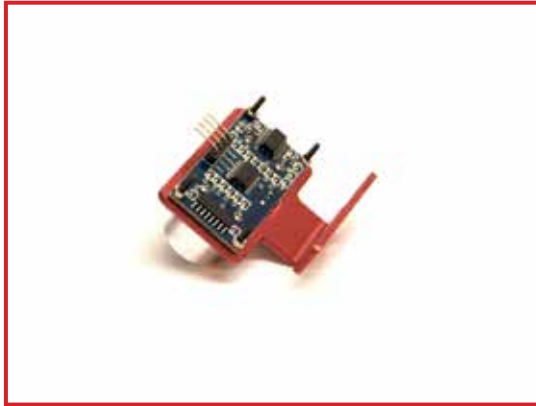
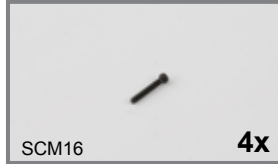

# 14

---

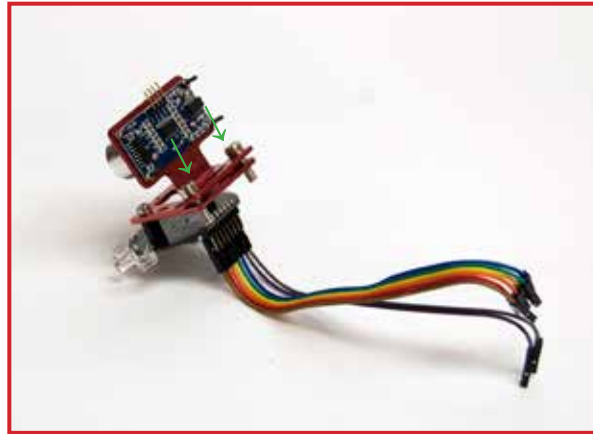

# 15

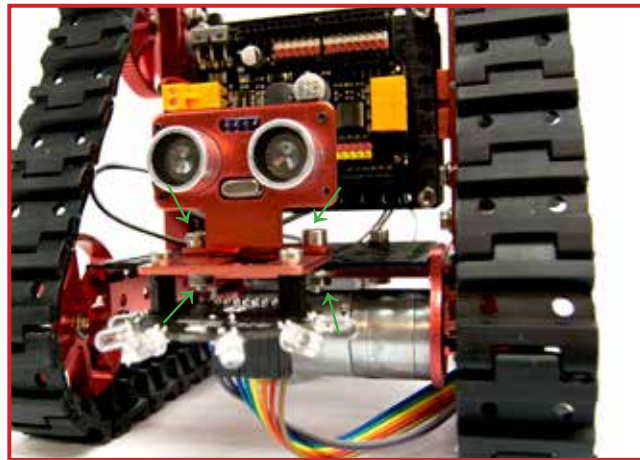
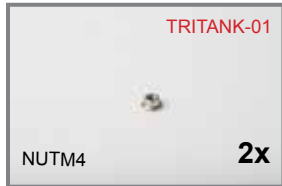

# 16

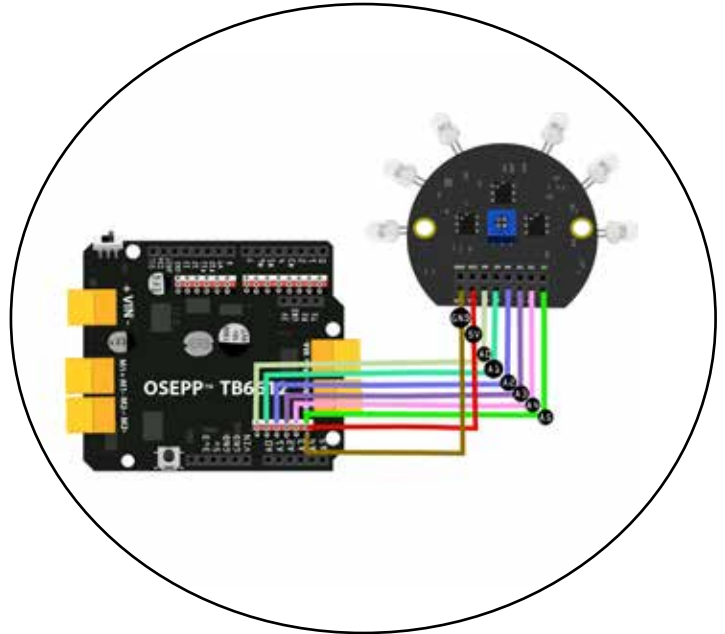
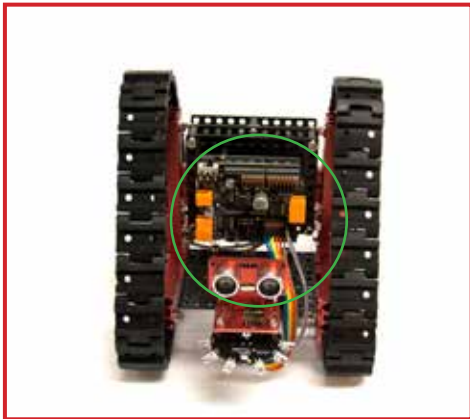



# 17

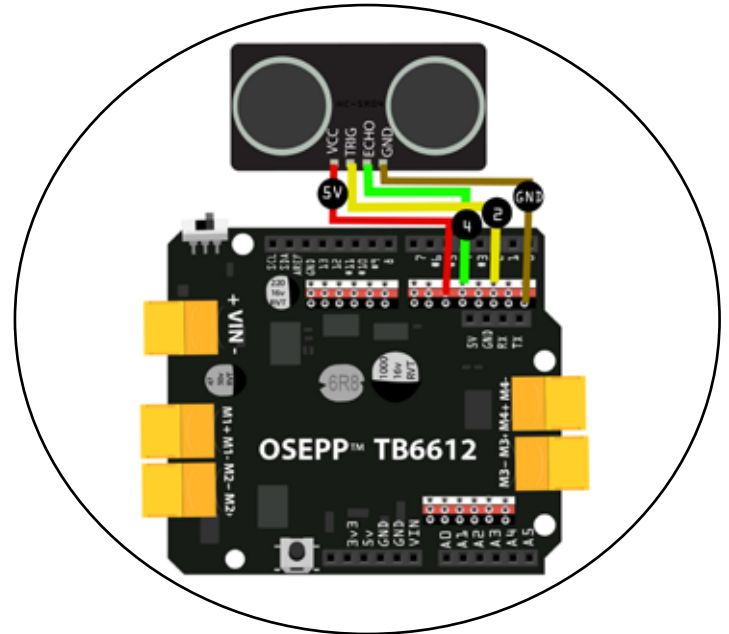
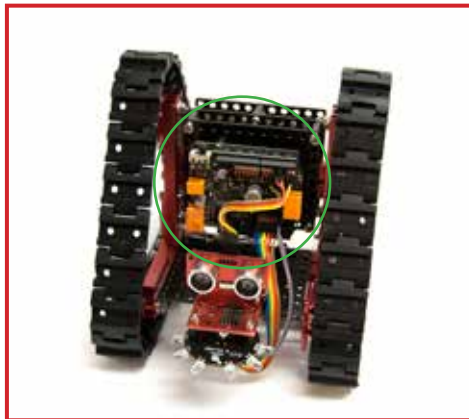

# 18

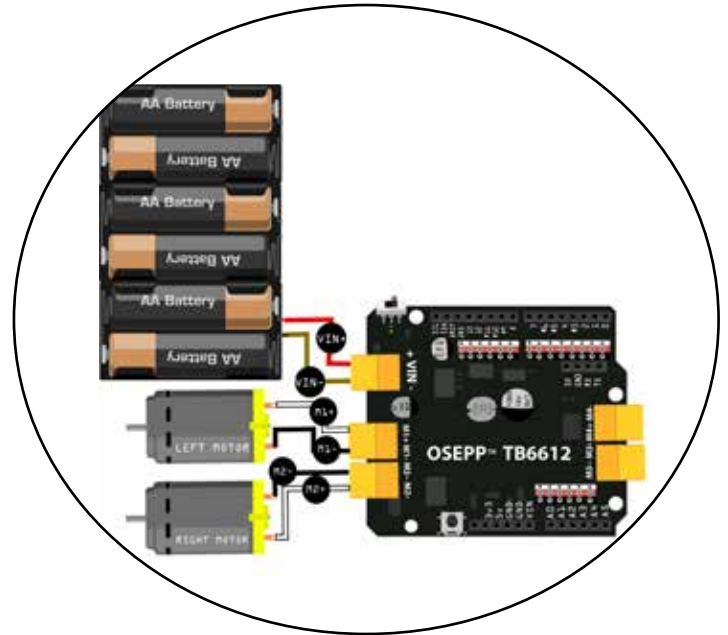
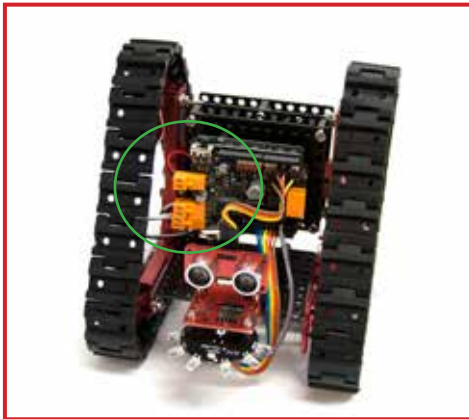

# 1

# TRIANGULAR TANK

Line Following with Obstacle Detection



# 2

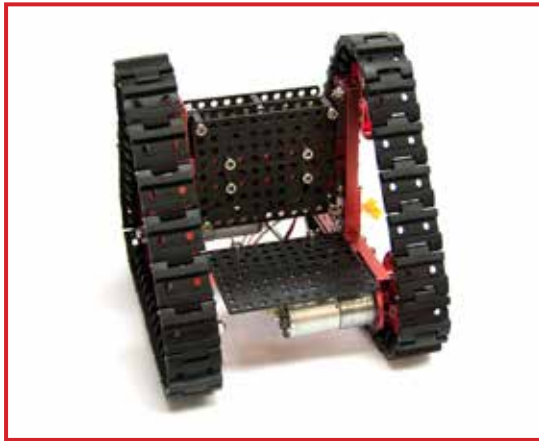

# 3

---

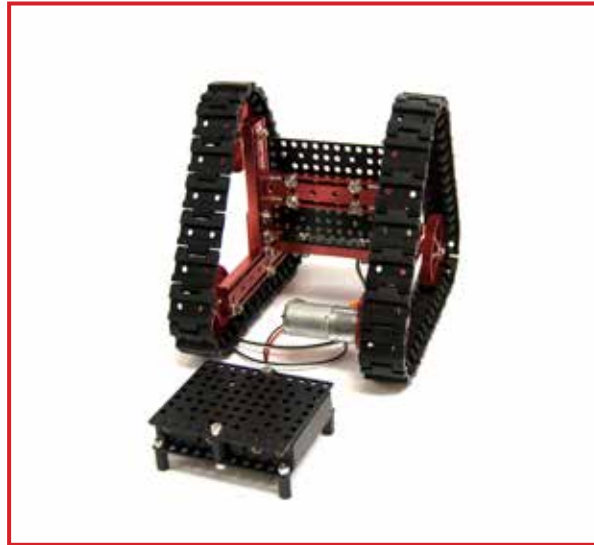

# 4

---



# 5

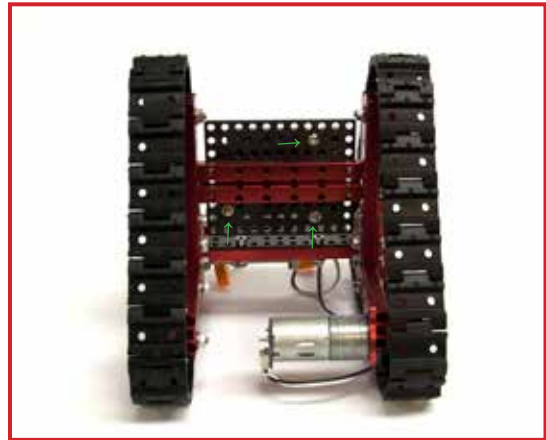
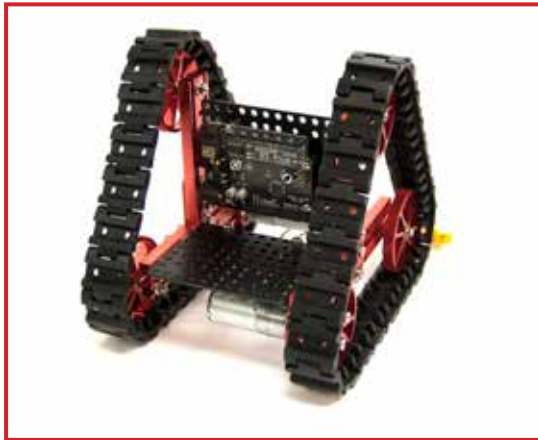

# 6

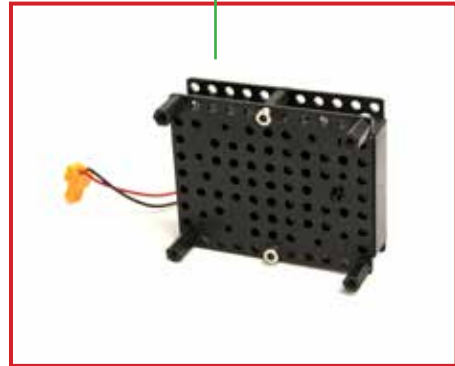
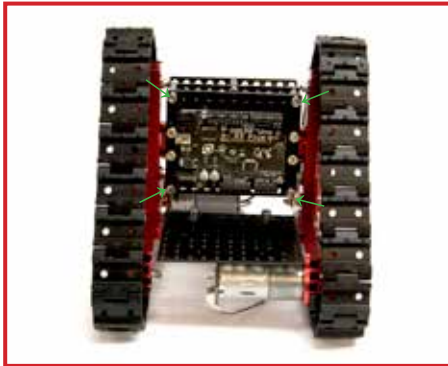
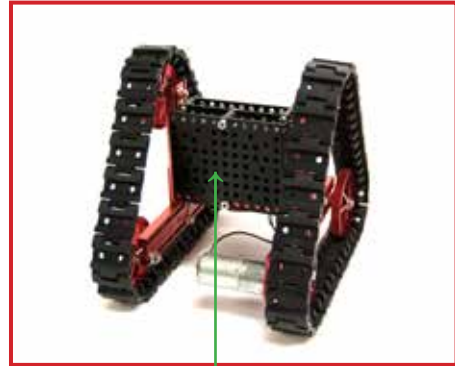



# 7

---

TBSHD-01



1x



# 8

---



# 9

---

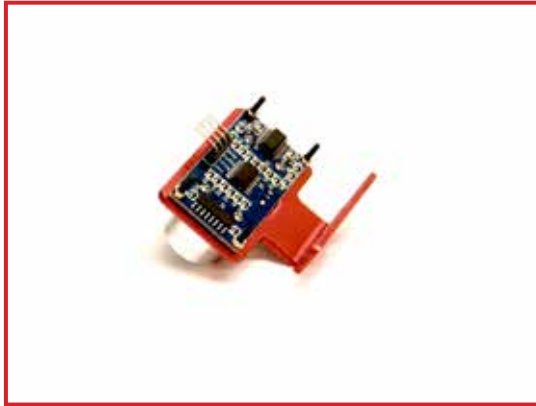
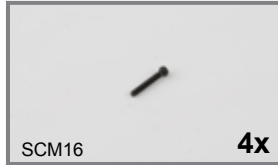

# 10

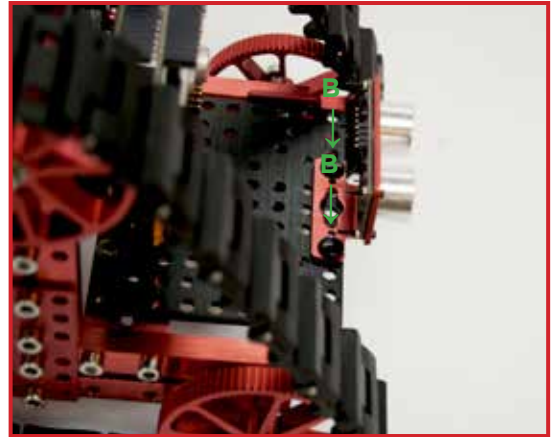
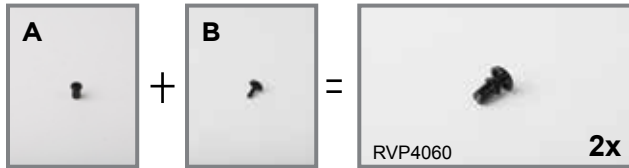

# 11

---



# 12

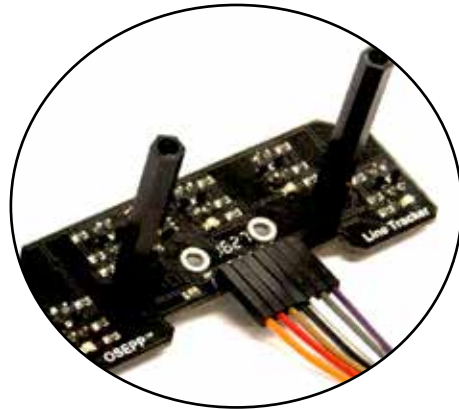
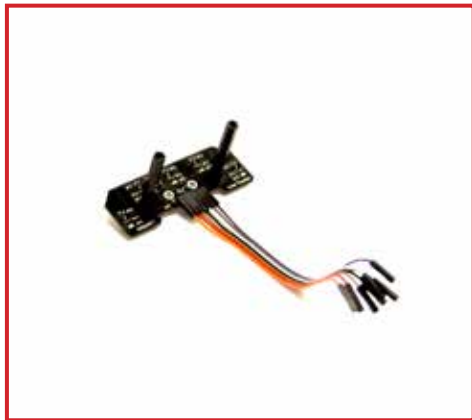

# 13

---

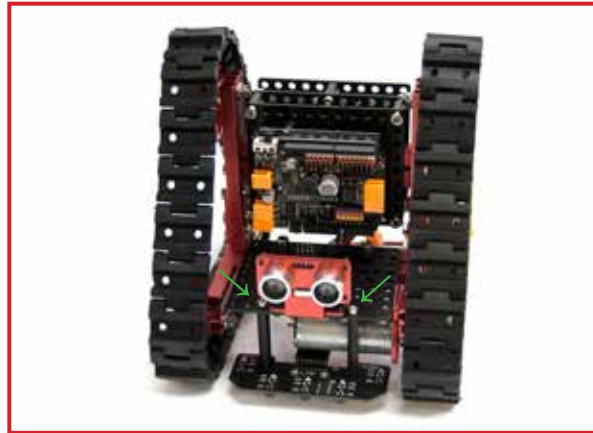

# 14

---

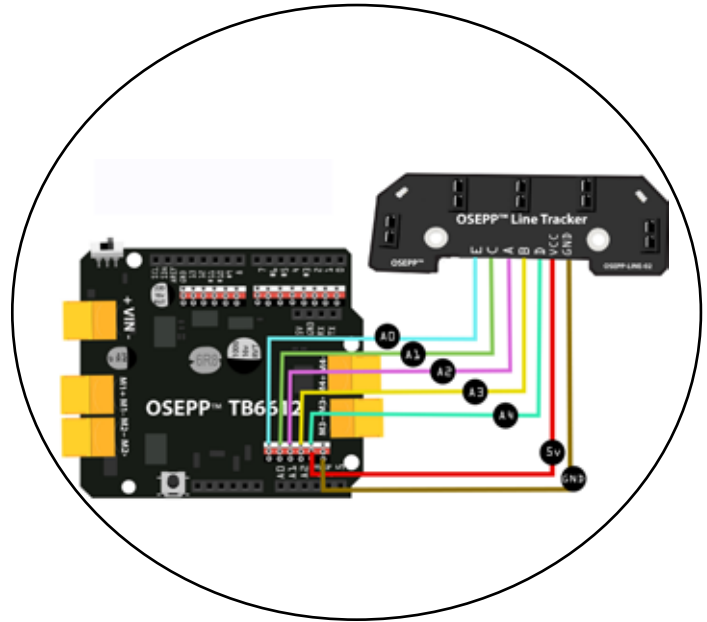
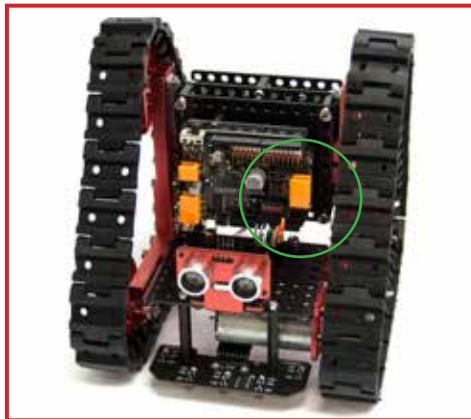



# 15

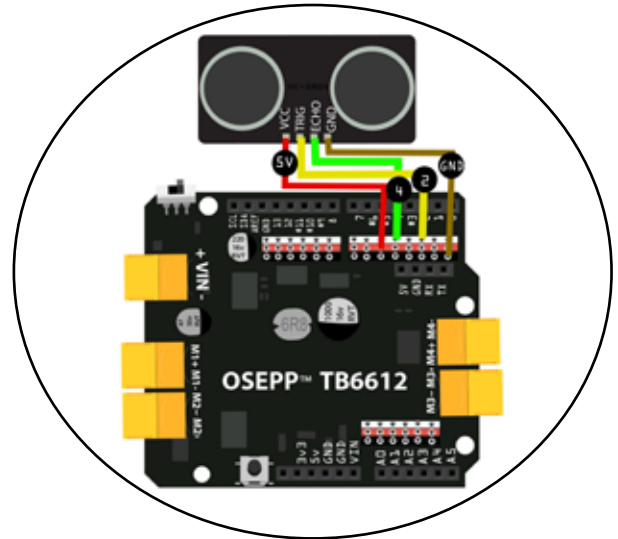
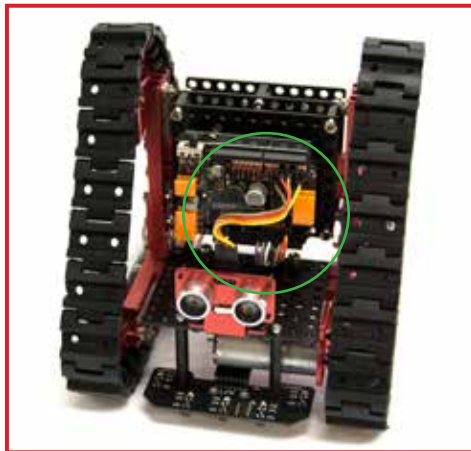

# 16

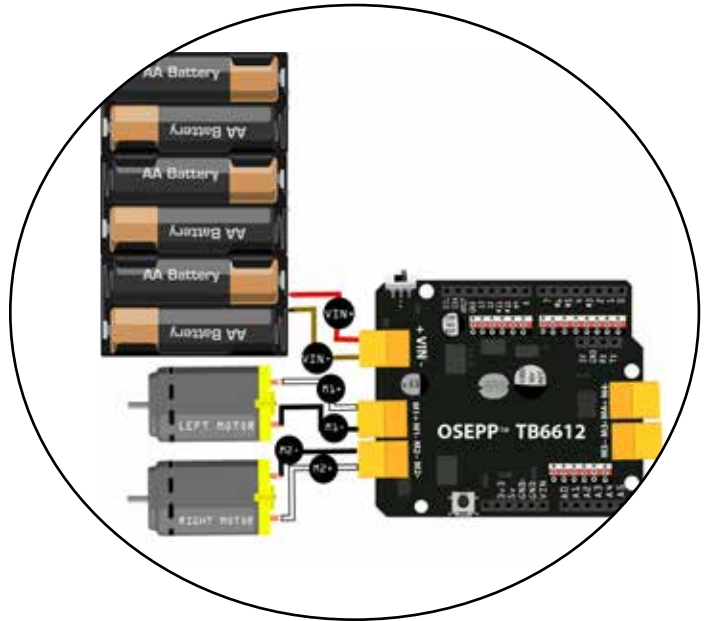
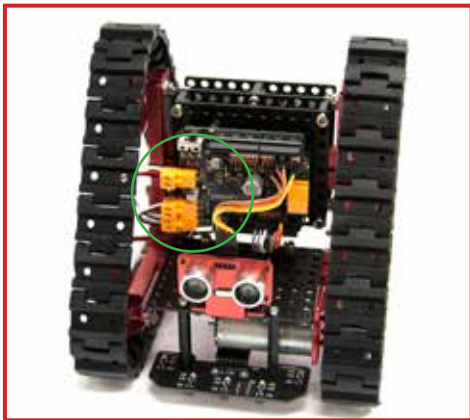

# 1

# TRIANGULAR TANK

Line Maze Discovery



TRITANK-01

1x



# 2

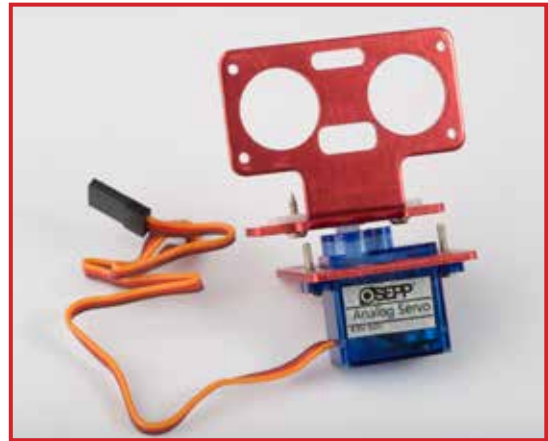
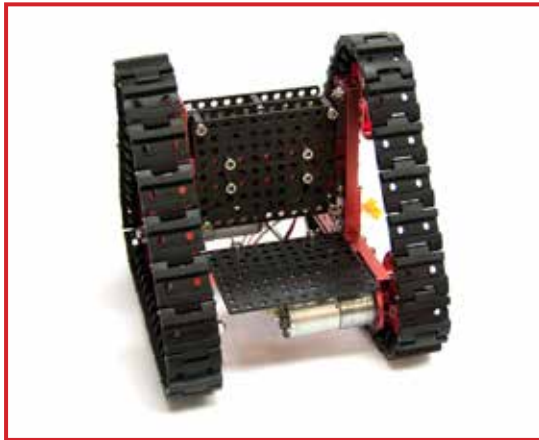

# 3

---

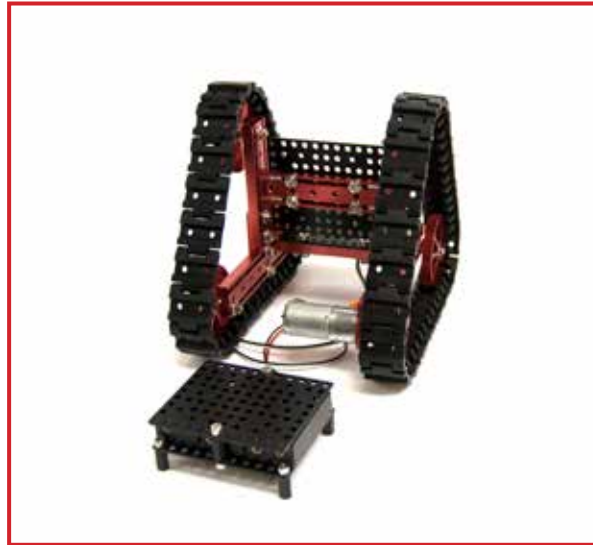

# 4

---

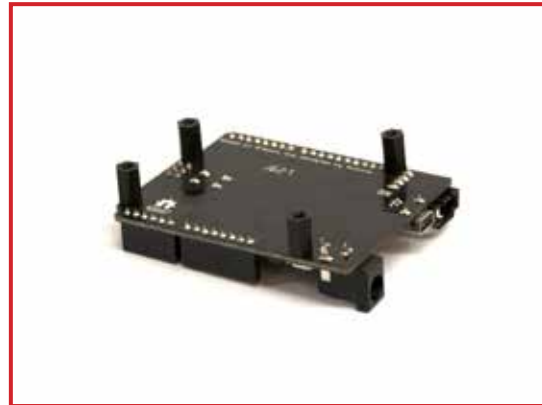
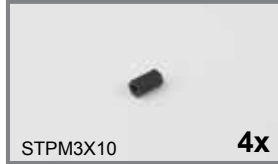

# 5

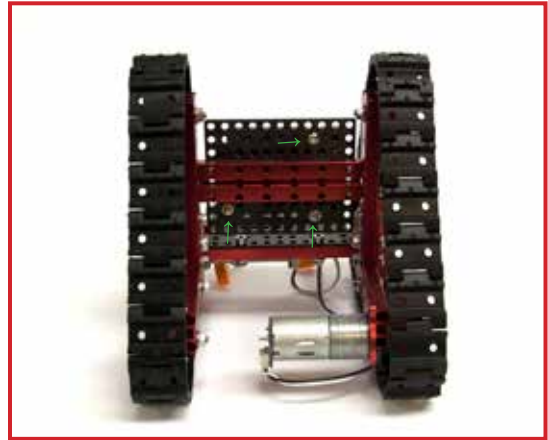
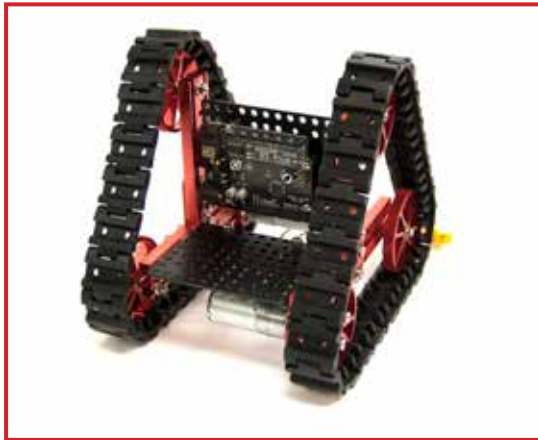

# 6

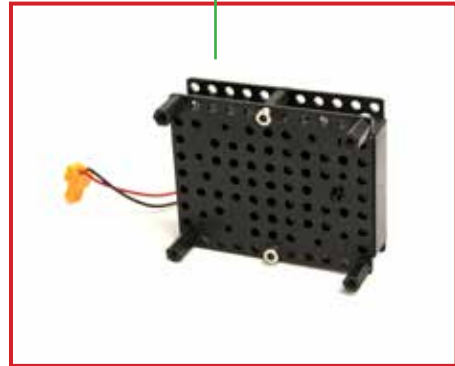
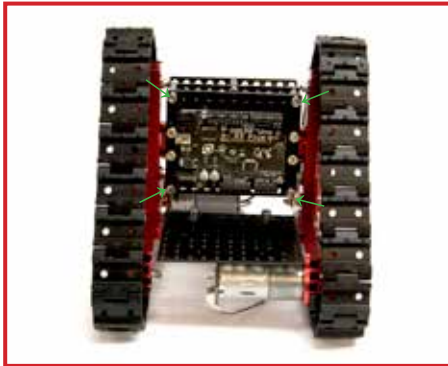
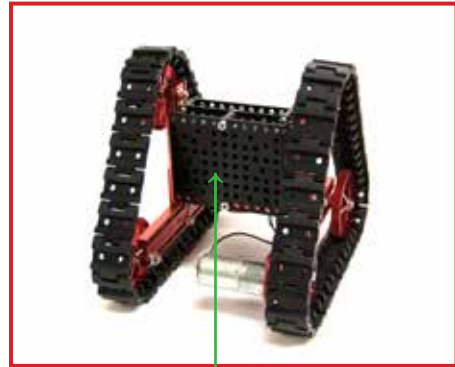



# 7

---

TBSHD-01



1x



# 8

---



# 9

---

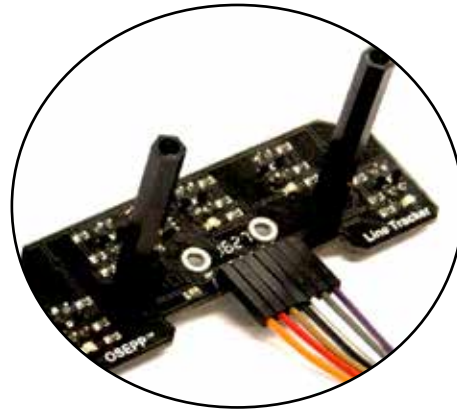
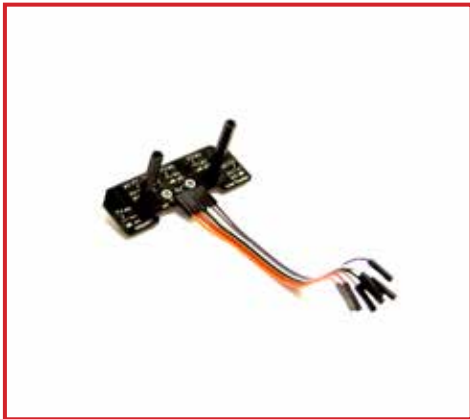

# 10

---

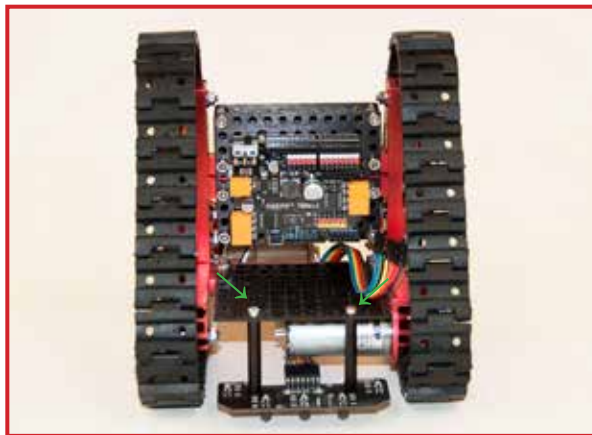

# 11

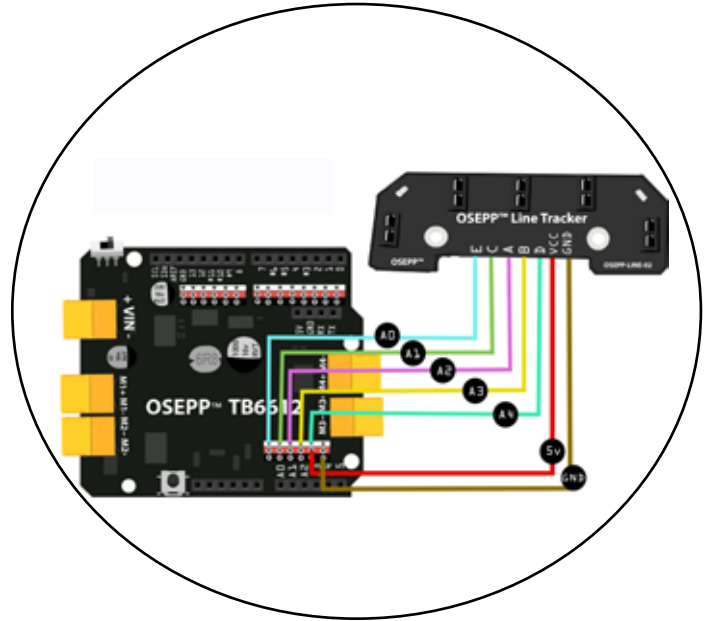
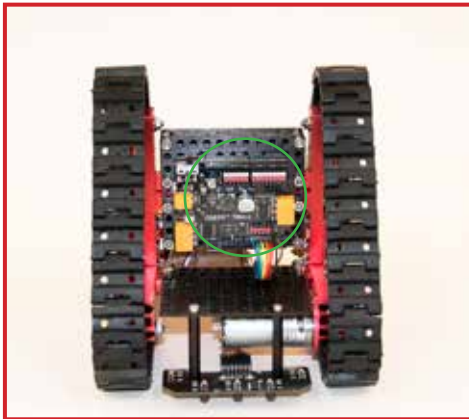

# 12

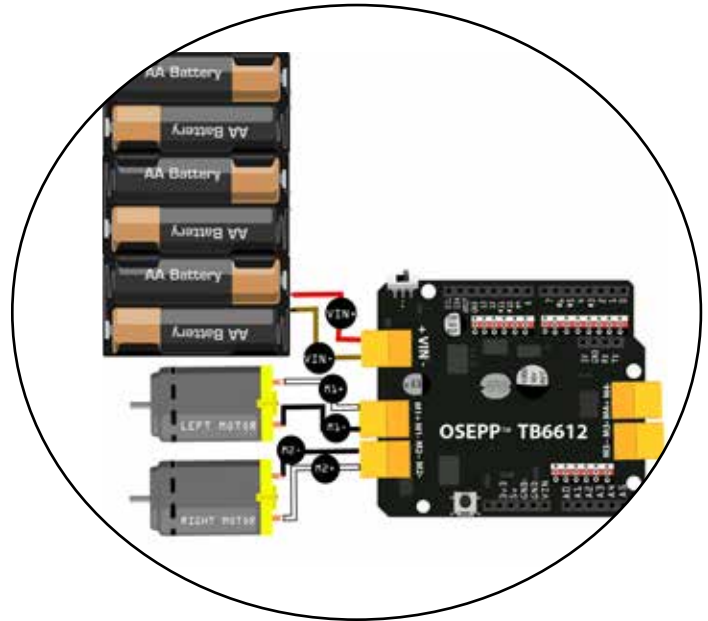
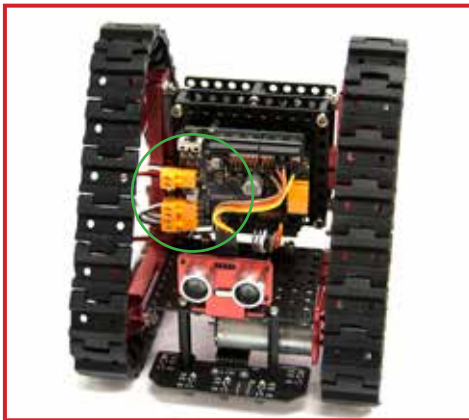

# 1

# TRIANGULAR TANK

Object avoidance



# 2

---

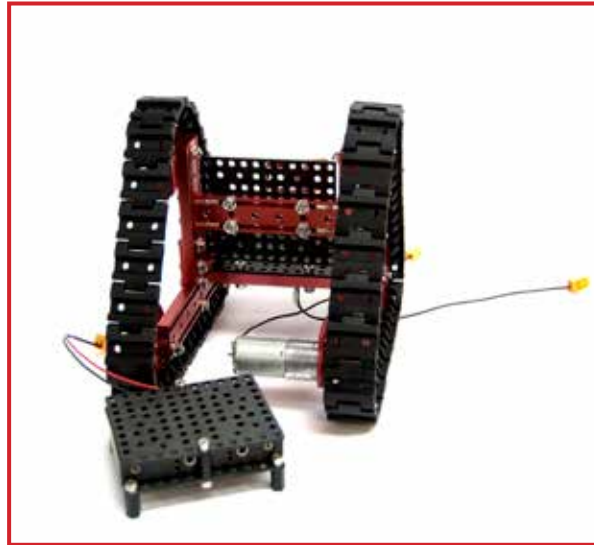



# 3

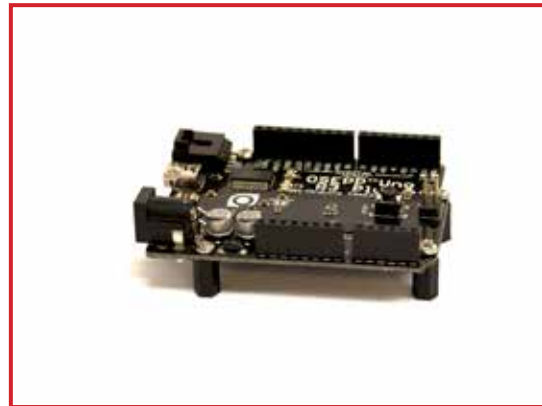

# 4

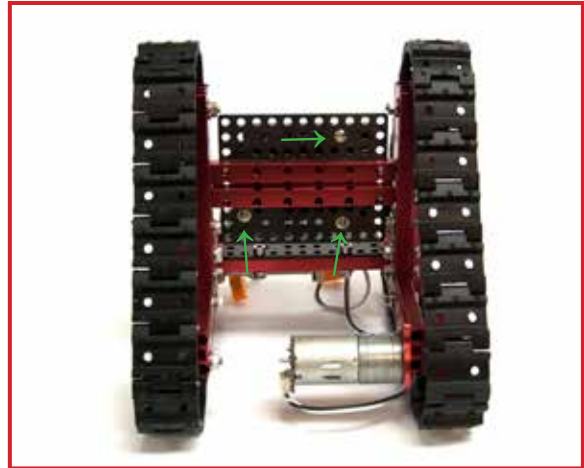
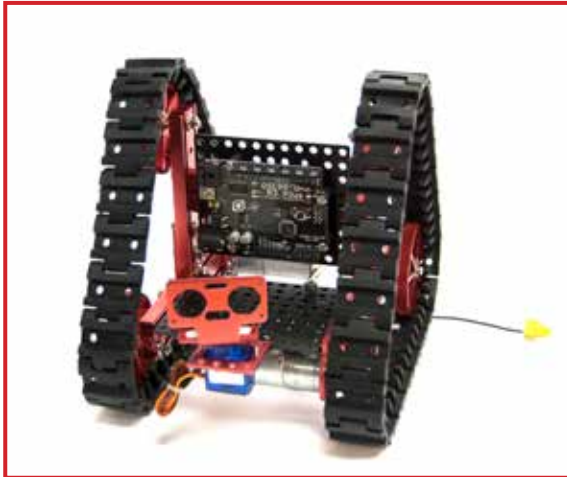

# 5

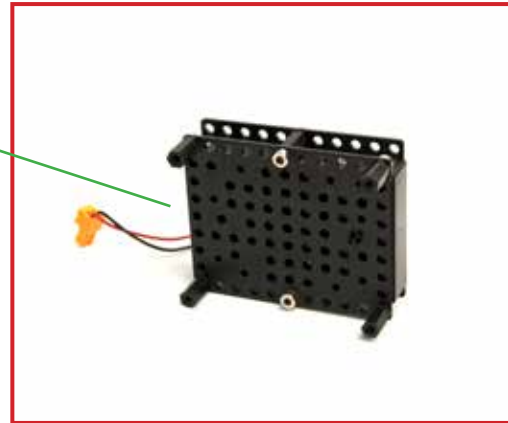
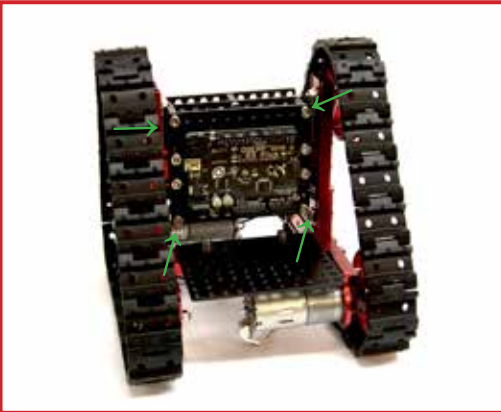
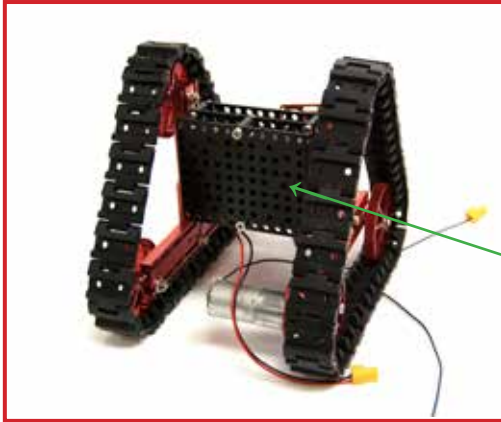

# 6

---

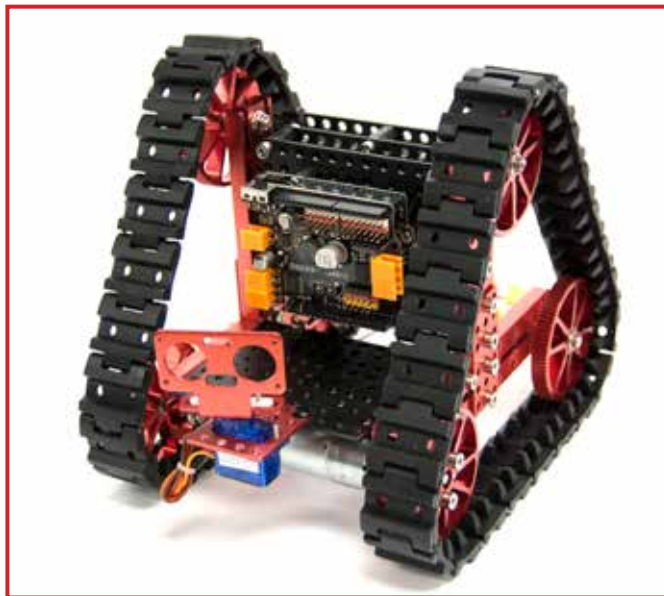

# 7

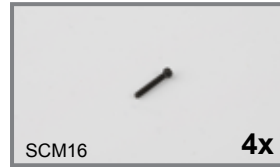

SCM16  
NUTM6

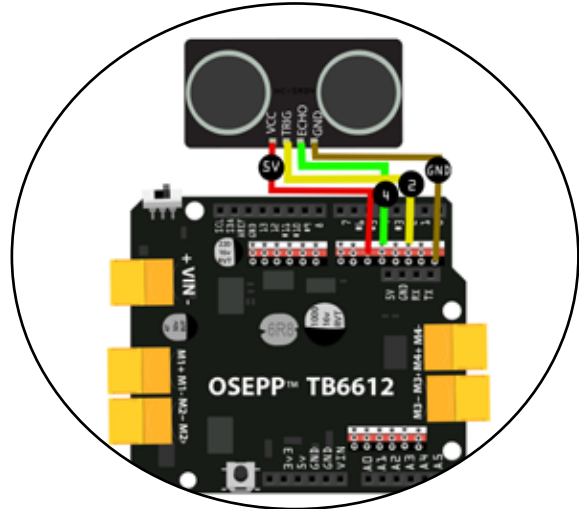
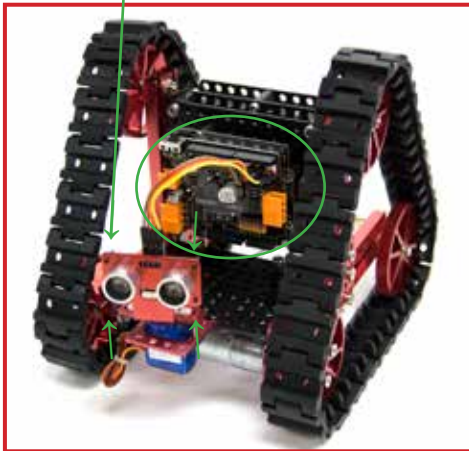

# 8

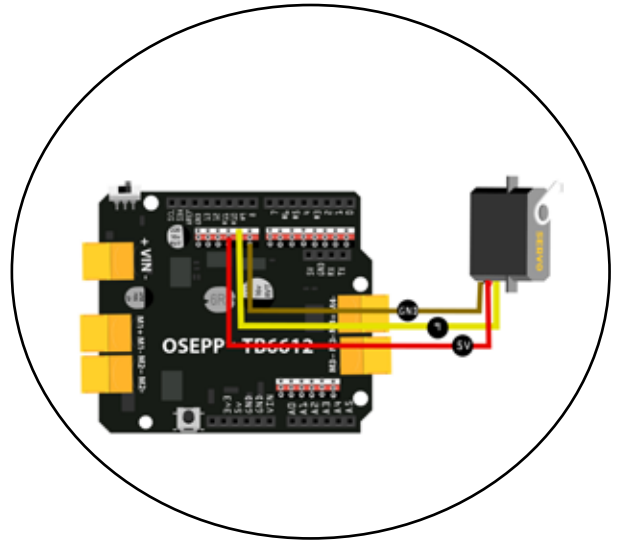
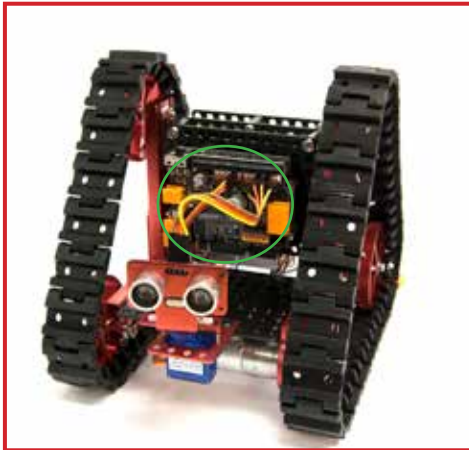

# 9

