

Digital universal particle concentration sensor

PMS1003 series data manual

Writer	Zhou Yong	Version	V2.5
Verifier	Zheng Haoxin	Date	2016-06-01

Main characteristics

- ◆ Zero false alarm rate
- ◆ Real-time response
- ◆ Correct data
- ◆ Minimum distinguishable particle diameter :0.3 micrometer



Overview

PMS1003 is a kind of digital and universal particle concentration sensor, which can be used to obtain the number of suspended particles in the air, i.e. the concentration of particles, and output them in the form of digital interface. This sensor can be inserted into variable instruments related to the concentration of suspended particles in the air or other environmental improvement equipments to provide correct concentration data in time.

Working principle

Laser scattering principle is used for such sensor, i.e. produce scattering by using laser to radiate suspending particles in the air, then collect scattering light in a certain degree, and finally obtain the curve of scattering light change with time. In the end, equivalent particle diameter and the number of particles with different diameter per unit volume can be calculated by microprocessor based on MIE theory. Please find the functional diagram of each part of sensor from Figure 1 as follows.

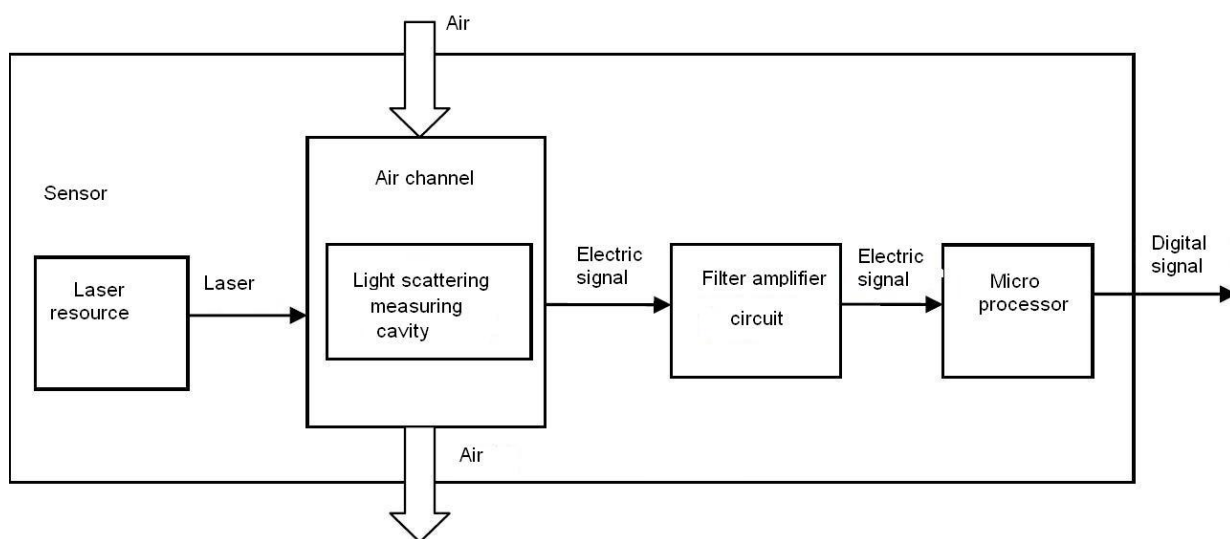

Figure 1 Functional block diagram of sensor

Technical Index

Parameter	Index	unit
Range of measurement	0.3~1.0; 1.0~2.5; 2.5~10	Micrometer (μm)
Counting Efficiency	50%@0.3 μm 98%@ $\geq 0.5\mu\text{m}$	
Effective Range (PM2.5 standard)	0~500	$\mu\text{g}/\text{m}^3$
Maximum Range (PM2.5 standard) *	≥ 1000	$\mu\text{g}/\text{m}^3$
Resolution	1	$\mu\text{g}/\text{m}^3$
Maximum Consistency Error (PM2.5 standard data)*	$\pm 10\%$ @100~500 $\mu\text{g}/\text{m}^3$ $\pm 10\mu\text{g}/\text{m}^3$ @0~100 $\mu\text{g}/\text{m}^3$	
Standard Volume	0.1	Litre (L)
Single Response Time	<1	Second (s)
Total Response Time	≤ 10	Second (s)
DC Power Supply	Typ:5.0 Min:4.5 Max: 5.5	Volt (V)

Active Current	≤ 100	Milliampere (mA)
Standby Current	≤ 200	Microampere (μA)
Interface Level	L < 0.8 @ 3.3 H > 2.7 @ 3.3	Volt (V)
Working Temperature Range	-10~+60	°C
Working Humidity Range	0~99%	
Storage Temperature Range	-40~+80	°C
MTTF	≥ 3	Year (Y)
Physical Size	65×42×23	Millimeter (mm)

Note 1: Maximum range means that the highest output value of the PM2.5 standard data is not less than 1000.

Note 2: "PM2.5 standard data" is the "data2" in the appendix.

Pin Definition



Figure 2 Connector Definition

PIN1	VCC	Positive power 5V
PIN2	GND	Negative power
PIN3	SET	Set pin /TTL level @3.3V, high level or suspending is normal working status, while low level is sleeping mode.
PIN4	RX	Serial port receiving pin/TTL level@3.3V
PIN5	TX	Serial port sending pin/TTL level@3.3V
PIN6	RESET	Module reset signal /TTL level@3.3V, low reset.
PIN7/8	NC	

Output result

Mainly output as the quality and number of each particles with different size per unit volume, the unit volume of particle number is 0.1L and the unit of mass concentration is $\mu\text{g}/\text{m}^3$.

There are two options for digital output: passive and active. Default mode is active after power up. In this mode sensor would send serial data to the host automatically. The active mode is divided into two sub-modes: stable mode and fast mode. If the concentration change is small the sensor would run at stable mode with the real interval of 2.3s. And if the change is big the sensor would be changed to fast mode automatically with the interval of 200~800ms, the higher of the concentration, the shorter of the interval.

Typical Circuit

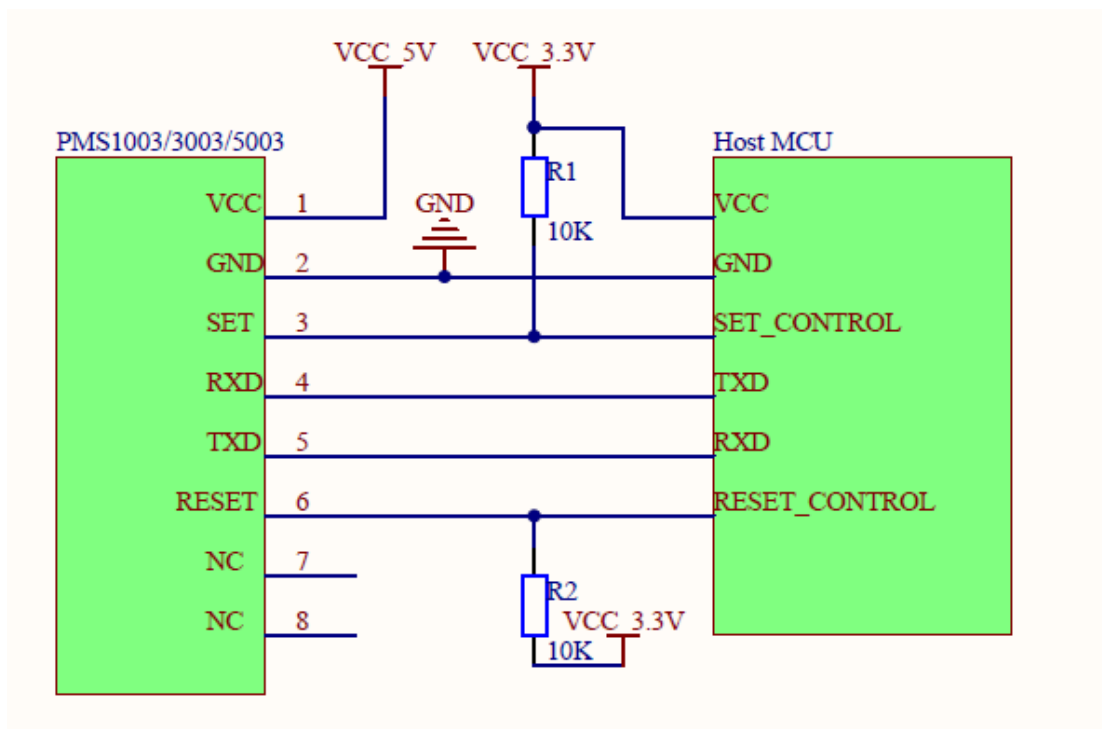

Figure 3 Typical Circuit

Typical Output Characteristic

Definition of axis Y: PM2.5 concentration , unit: $\mu\text{g}/\text{m}^3$

Definition of axis X: number of samples, unit: time

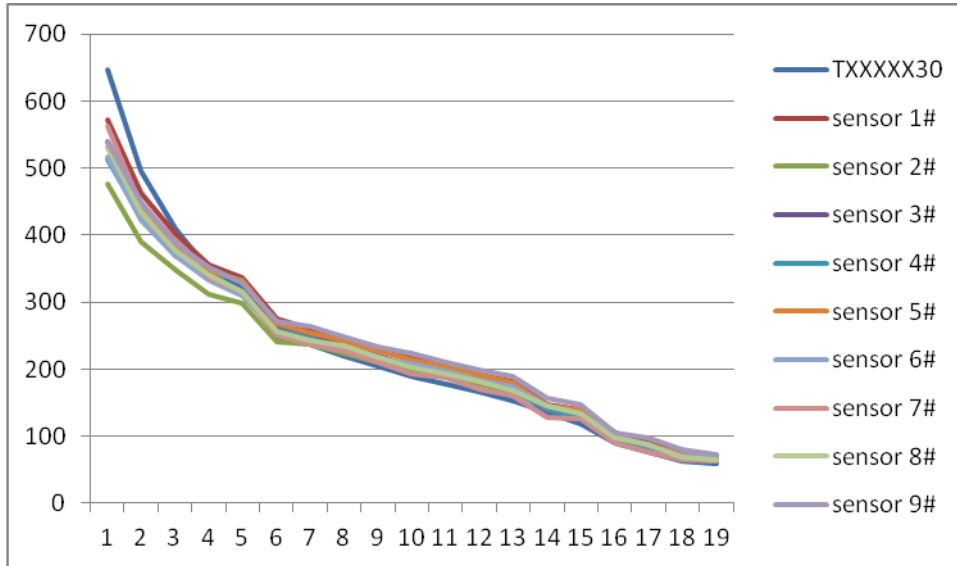

Figure 4-1 Consistency at 20°C

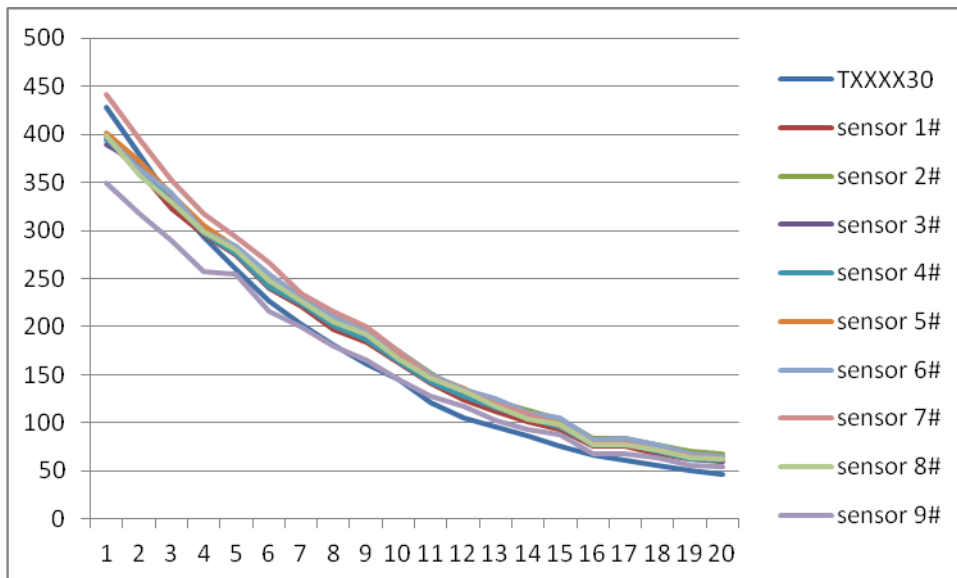

Figure 4-2 Consistency at 43°C

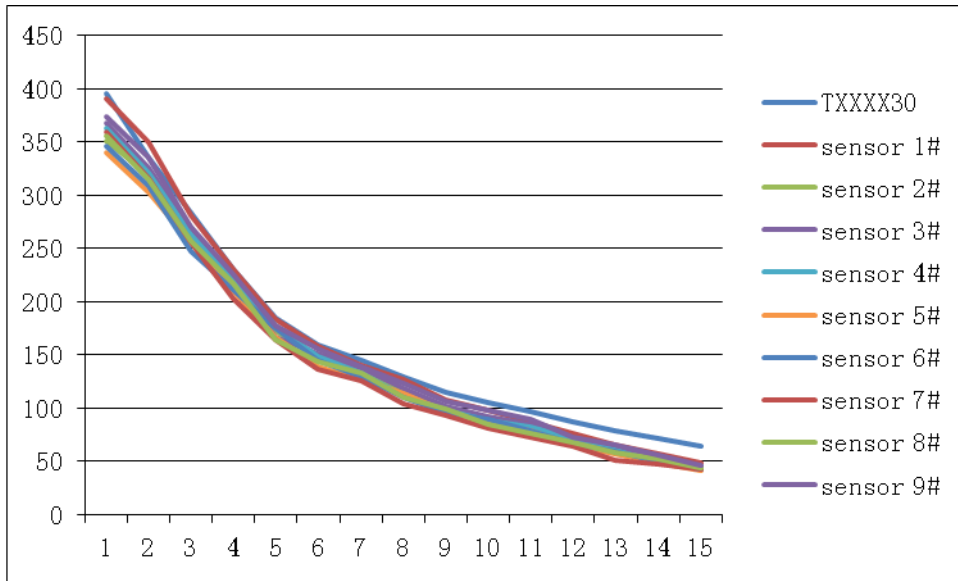

Figure 4-3 Consistency at -5°C

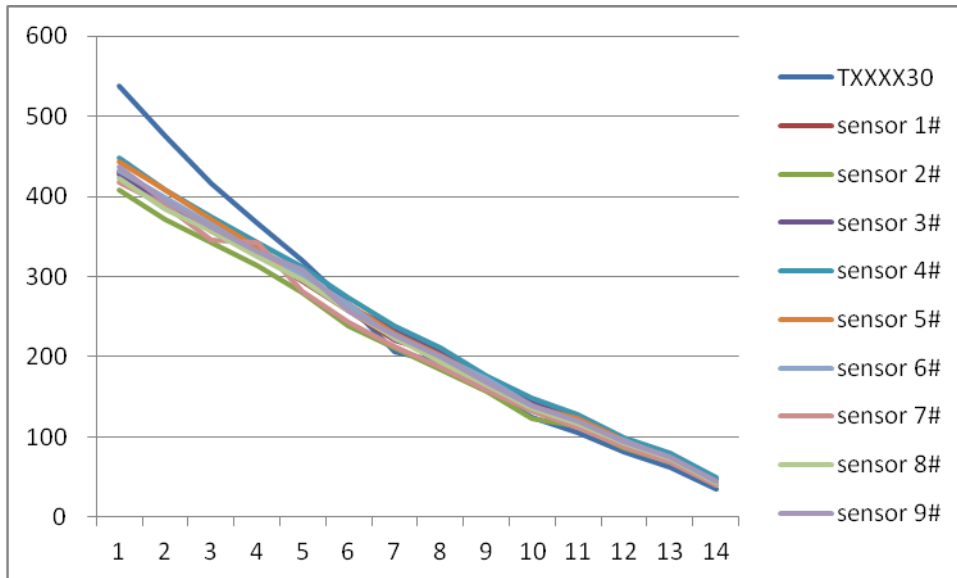

Figure 4-4 Consistency after 30 days' running

Relationship of Temperature and Consistency

Definition of axis Y: Maximum Error Modulus(%)

Definition of axis X: Temperature(°C)

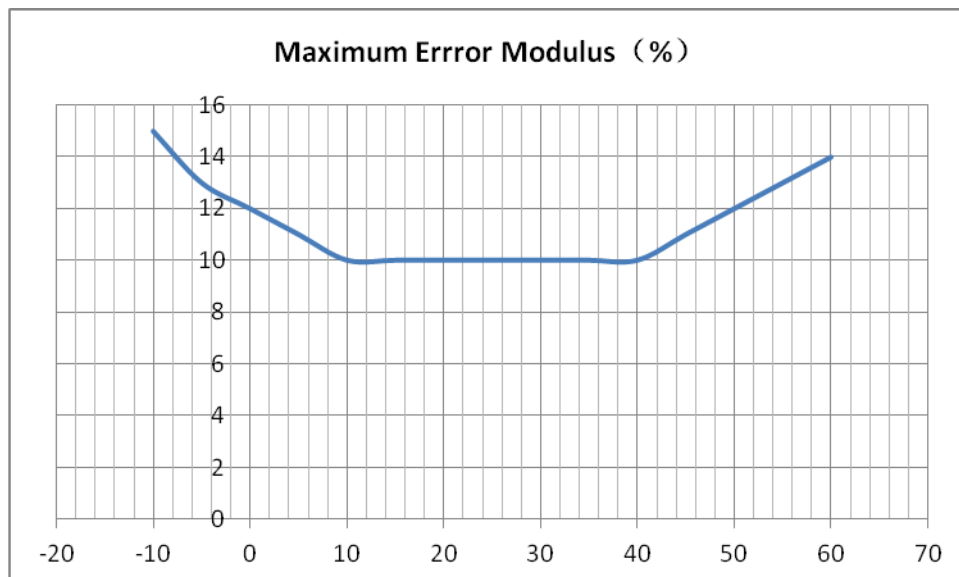

Figure 5 Consistency Vs Temperature

Endurance Characteristics

No	Item	Test Method	Characteristics	n C
1	Long Running	<ol style="list-style-type: none"> 10 m² closed Lab,, 20~25°C , humidity 30%~70%, particle generator and air cleaner DC 5V power supply Check consistency after 720 hours' running 	10 samples during 0~500μ g/m ³ 0~100μ g/m ³ Maximum Error ≤ ± 15μ g/m ³	n=30 C=0
2	High Temperature Operation	<ol style="list-style-type: none"> 10 m² constant temperature Lab 43°C , humidity 70%, particle generator and air cleaner DC 5V power supply Check consistency 	100~500μ g/m ³ Maximum Error ≤ ± 15%	n=10 C=0
3	Cold Operation	<ol style="list-style-type: none"> 10 m² constant temperature Lab -5°C , humidity 30%, particle generator and air cleaner DC 5V power supply Check consistency 	FAN does not screeched	n=10 C=0

4	Vibration	<ol style="list-style-type: none"> 10 m² closed Lab., 20°C, humidity 50%, particle generator and air cleaner DC 5V power supply and check consistency Frequency: 50Hz。 acceleration: 9.8/ S² 。 Direction: X、Y、Z Vibration Amplitude: ±2mm。 Time: X、Y、Z –way, Per 1 hour 		n=5 C=0
5	High Temperature and Humidity Storage	<ol style="list-style-type: none"> Constant temperature cabinet 70°C, humidity 90%~95, Check consistency after 500 hours' storage 	<p>10 samples during 0~500μ g/m³</p> <p>0~100μ g/m³ Maximum Error ≤</p>	n=10 C=0
6	Cold Storage	<ol style="list-style-type: none"> Constant temperature cabinet -30°C, humidity 90%~95, Check consistency after 500 hours' storage 	<p>± 10μ g/m³</p> <p>100~500μ g/m³ Maximum Error ≤</p> <p>± 10%</p>	n=10 C=0
7	Variation of Power Supply	<ol style="list-style-type: none"> 10 m² closed Lab., 20°C, humidity 50%, particle generator and air cleaner Power varies as the cycles of 4.5V to 5.5V ,then 5.5V to 4.5V with the pace of 0.1V/min for 2 hours. Check consistency during Variation 	<p>FAN does not screeched</p>	n=5 C=0
8	Power On-Off Cycle	<ol style="list-style-type: none"> 10 m² closed Lab., 20°C, humidity 50%, particle generator and air cleaner DC 5V power supply, keep On-Off frequency 0.5Hz for 72 hours and check consistency 		n=10 C=0
9	Sleep Set On-Off Cycle	<ol style="list-style-type: none"> 10 m² closed Lab., 20°C, humidity 50%, particle generator and air cleaner DC 5V power supply, keep Sleep Set Pin High-Low frequency 0.5Hz for 72 hours and check consistency 		n=10 C=0
10	Laser On-Off	<ol style="list-style-type: none"> 10 m² closed Lab., 20°C, humidity 		n=10

	Cycle	50%, particle generator and air cleaner 2. keep laser On-Off frequency 50Hz for 240 hours and check consistency		C=0
11	Salt Spray	5% industrial salt water, hydrolysis spray 100 hours, clean with purified water and store for 48 hours	No rust and discoloration of metal parts	n=1 C=0

Circuit Attentions

- 1) DC 5V power supply is needed because the FAN should be driven by 5V. But the high level of data pin is 3.3V. Level conversion unit should be used if the power of host MCU is 5V.
- 2) The SET and RESET pins are pulled up inside so they should not be connected if without usage.
- 3) PIN7 and PIN8 should not be connected.
- 4) Stable data should be got at least 30 seconds after the sensor wakeup from the sleep mode because of the fan's performance.

Installation Attentions

- 1) Metal shell is connected to the GND so be careful not to let it shorted with the other parts of circuit except GND.
- 2) The best way of install is making the inset and outset closely to the plane of the host. Or some shield should be placed between inset and outset in order to prevent the air flow from inner loop.
- 3) The blowhole in the shell of the host should not be smaller than the inset.
- 4) The sensor should not be installed in the air flow way of the air cleaner or should be shielded by some structure.
- 5) The sensor should be installed at least 20cm higher than the grand in order to prevent it from blocking by the flock dust.
- 6) Do not break up the sensor.

Other Attentions

- 1) Only the consistency of all the PM sensors of PLANTOWER is promised and ensured. And the sensor should not be checked with any third party equipment.
- 2) The sensor is usually used in the common indoor environment. So some protection must be added if using in the conditions as followed:

- a) The time of concentration $\geq 300 \mu\text{g}/\text{m}^3$ is longer than 50% of the whole year or concentration $\geq 500 \mu\text{g}/\text{m}^3$ is longer than 20% of the whole year.
- b) Kitchen
- c) Water mist condition such as bathroom or hot spring.
- d) outdoor

Part Number Definition

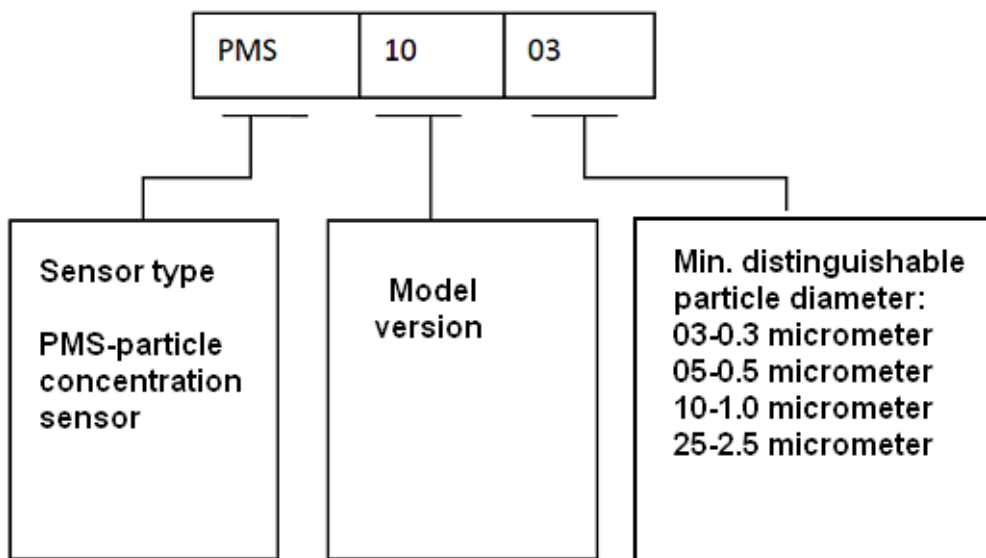

Physical Size (mm)

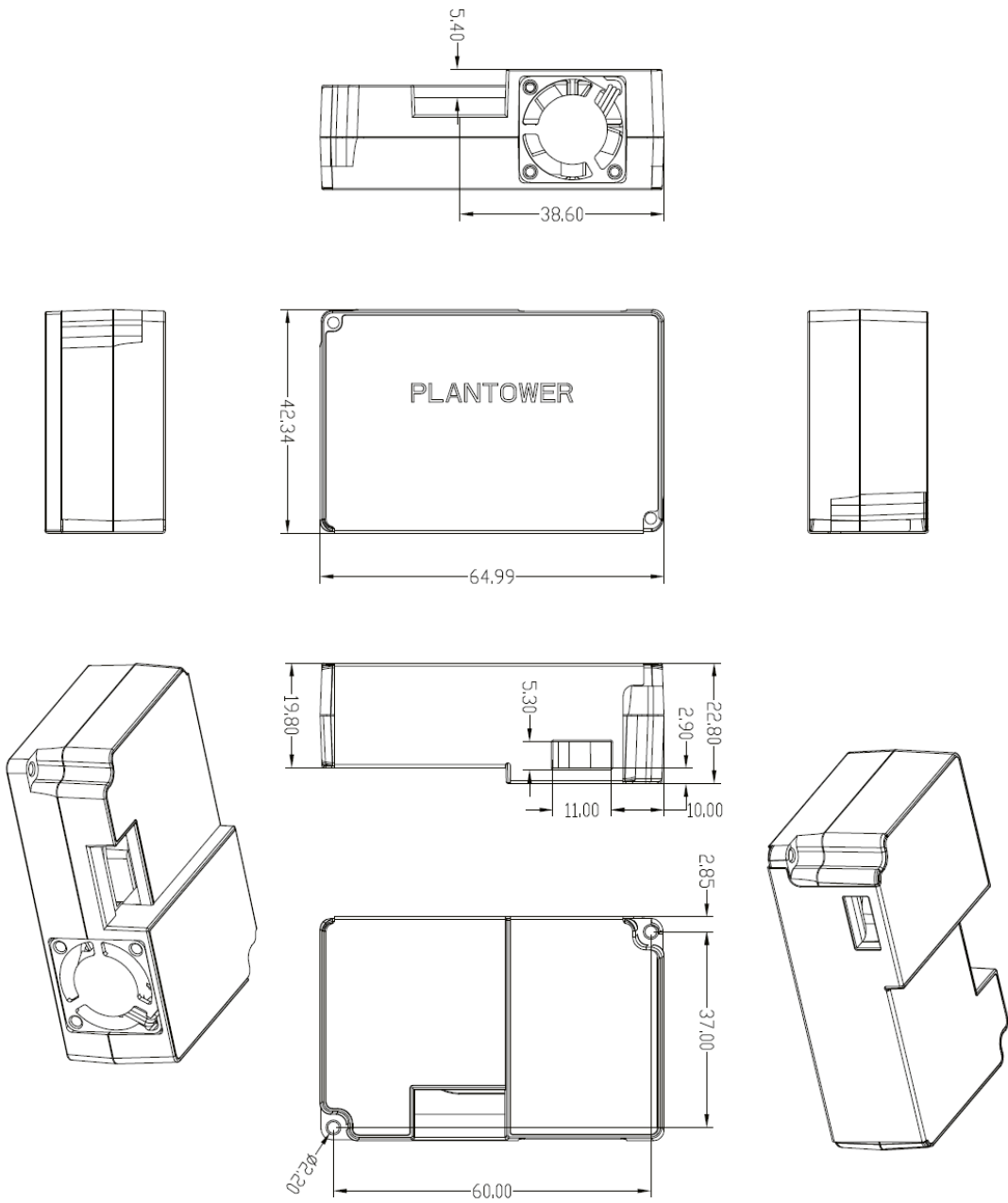

Appendix I: PMS1003 transport protocol-Active Mode

Default baud rate: 9600bps Check bit: None Stop bit: 1 bit

32 Bytes

Start character 1	0x42	(Fixed)
Start character2	0x4d	(Fixed)
Frame length high 8 bits	Frame length=2x13+2(data+check bytes)
Frame length low 8 bits	
Data 1 high 8 bits	Data1 refers to PM1.0 concentration unit μ g/m ³ (CF=1, standard particle) *
Data 1 low 8 bits	
Data2 high 8 bits	Data2 refers to PM2.5 concentration unit μ g/m ³ (CF=1, standard particle)
Data2 low 8 bits	
Data3 high 8 bits	Data3 refers to PM10 concentration unit μ g/m ³ (CF=1, standard particle)
Data3 low 8 bits	
Data4 high 8 bits	Data4 refers to PM1.0 concentration unit * μ g/m ³ (under atmospheric environment)
Data4 low 8 bits	
Data5 high 8 bits	Data 5 refers to PM2.5 concentration unit μ g/m ³ (under atmospheric environment)
Data5 low 8 bits	
Data6 high 8 bits	Data 6 refers to concentration unit (under atmospheric environment) μ g/m ³
Data6 low 8 bits	
Data7 high 8 bits	Data7 indicates the number of particles with diameter beyond 0.3 μ m in 0.1 L of air.
Data7 low 8 bits	
Data8 high 8 bits	Data 8 indicates the number of particles with diameter beyond 0.5 μ m in 0.1 L of air.
Data8 low 8 bits	
Data9 high 8 bits	Data 9 indicates the number of particles with diameter beyond 1.0 μ m in 0.1 L of air.
Data9 low 8 bits	

Data10 high 8 bits	Data10 indicates the number of particles with diameter beyond 2.5 um in 0.1 L of air.
Data10 low 8 bits	
Data11 high 8 bits	Data11 indicates the number of particles with diameter beyond 5.0 um in 0.1 L of air.
Data11 low 8 bits	
Data12 high 8 bits	Data12 indicates the number of particles with diameter beyond 10 um in 0.1 L of air.
Data12 low 8 bits	
Data13 high 8 bits	Data13 Reserved
Data13 low 8 bits	
Data and check high 8 bits	Check code=Start character 1+ Start character 2+.....+data 13 Low 8 bits
Data and check low 8 bits	

Note: CF=1 should be used in the factory environment

Appendix II: PMS1003 transport protocol-Passive Mode

Default baud rate: 9600bps Check bit: None Stop bit: 1 bit

Host Protocol

Start Byte 1	Start Byte 2	Command	Data 1	Data 2	Verify Byte 1	Verify Byte 2
0x42	0x4d	CMD	DATAH	DATAL	LRCH	LRCL

1. Command Definition

CMD	DATAH	DATAL	说明
0xe2	X	X	Read in passive mode
0xe1	X	00H-passive 01H-active	Change mode
0xe4	X	00H-sleep 01H-wakeup	Sleep set

2. Answer

0xe2: 32 bytes , same as appendix I

3. Verify Bytes :

Add of all the bytes except verify bytes.